

MINIMISING SELECTIVE FADING

MONTHLY
ONE SHILLING

The Wireless World

*COVERING
EVERY WIRELESS INTEREST*

AUGUST 1941



IN A RADIOLOCATION STATION



**SILVERED CERAMIC
FIXED CONDENSERS**
for Service & the Services

With negligible, positive or negative temperature co-efficient of capacity. Stable under all climatic influences. Normal or tropical finishes.

Send for Brochure.

CONTRACTORS TO GOVERNMENT DEPTS.

On A.I.D. APPROVED LIST.



UNITED INSULATOR CO LTD

The Pioneers of Low Loss Ceramics

12-16 LAYSTALL STREET, LONDON, E.C.1

Tel: TERMINUS 4118-9

Grams: GALANEL SMITH, LONDON

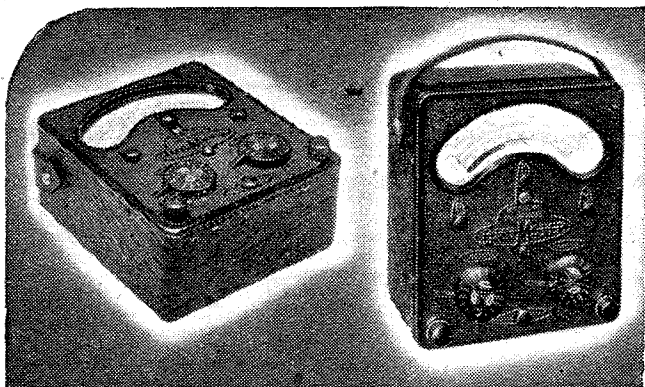

46-range Model 7
Universal AvoMeter

40-range Model 40
Universal AvoMeter

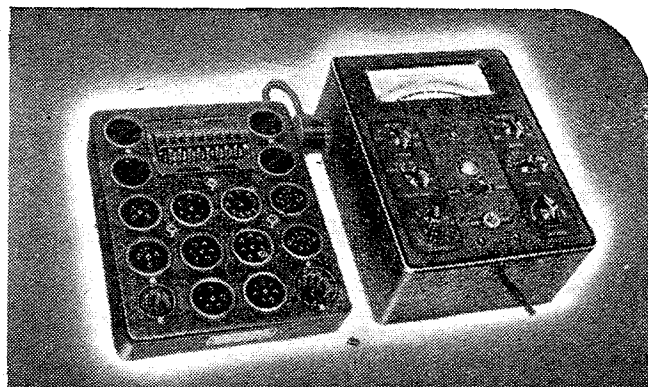

"Avo" Valve Tester with Universal Panel

PRECISION METERS

that Master every Testing Problem

The world-wide use of "AVO" Instruments is striking testimony to their outstanding versatility, precision and reliability. In every sphere of electrical test work—laboratory, shop or out on a job—they are appreciated for their dependable accuracy, which is often used as a standard by which other instruments are judged. There is an "AVO" Instrument for every essential electrical test.

In spite of greatly increased production, most of our output of "AVO" Instruments is being taken by the Services. Delay in delivery of Trade Orders is consequently inevitable but we shall continue to do our best to fulfil your requirements as promptly as possible.



Regd. Trade Mark

ELECTRICAL MEASURING INSTRUMENTS

BRITISH MADE

● Write for fully descriptive literature dealing with any instrument in which you are interested, and for current prices.

Sole Proprietors and Manufacturers:—

THE AUTOMATIC COIL WINDER & ELECTRICAL EQUIPMENT Co., Ltd., Winder House, Douglas St., London, S.W.1

Phone: Victoria 3404-7.

All-Wave "Avo" Oscillator

"Avo" Test Bridge

Universal AvoMinor

D.C. AvoMinor

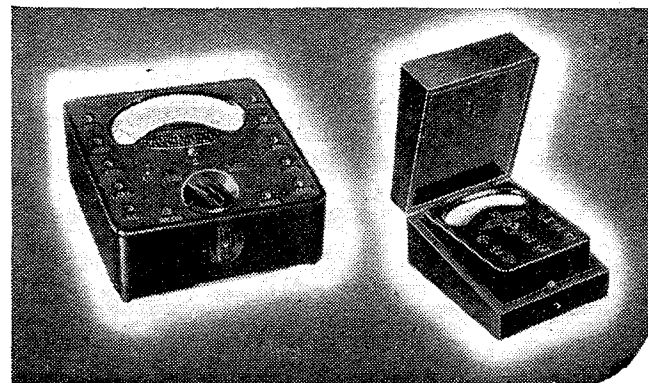
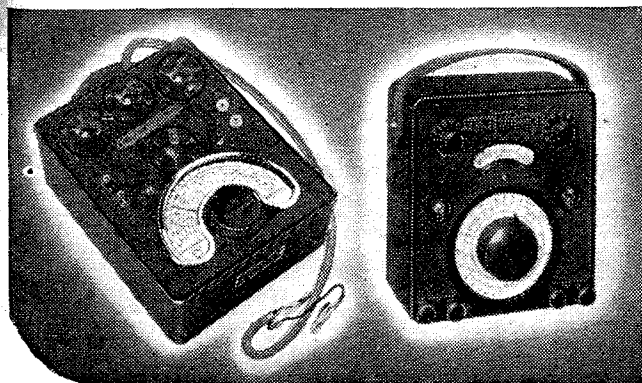

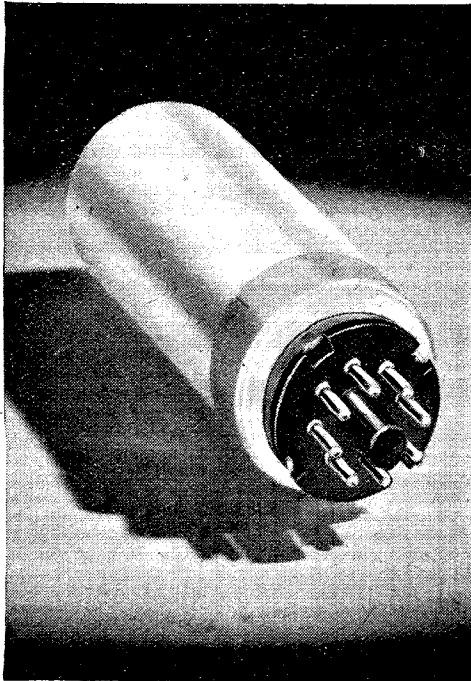

P. R. MALLORY & CO. Inc.
MALLORY
STRATOSPHERE VIBRATORS
SERIES 545

WITH the rapid progress of aviation, yesterday's altitude records are quickly becoming today's normal flying levels, and as man reaches higher and higher altitudes new problems must be solved—not least among them the problem of reliable radio communications.

From altitudes of 15,000 feet upwards, for instance, vibrators begin to lose efficiency. It is for this reason that Mallory, the world's leading vibrator specialists, have perfected special STRATOSPHERE vibrators—sealed completely airtight at normal pressure of 14.7 lbs. per sq. inch and capable of operation, with full efficiency, regardless of altitude or atmospheric pressure. Designed for 6, 12 or 24 volt service.

P. R. MALLORY & CO. INC.
INDIANAPOLIS . INDIANA . U.S.A.

★ Represented exclusively in Gt. Britain by
FRANK HEAVER LTD. . KINGSLEY RD. . BIDEFORD . N. DEVON . ENG.

**The British Institution of
Radio Engineers**

(Founded in 1933 as The Institution of Radio Engineers)

In Association with
The Institute of Wireless Technology
Founded 1925 Incorporated 1932

“In its responsibility for conducting the Institution's examinations, the Committee has done valuable work in providing a means of recognising the ability of students and offering to employers the means of securing qualified assistants.”

*From the Annual Report of the Council
June 1941.*

The next Graduateship Examination will be held in London and other Principal Centres on Friday (6 p.m.—9 p.m.) and Saturday (10 a.m.—5 p.m.) the 14th and 15th November, 1941.

Application forms must be obtained from:—

The Secretary,
**Duke St. House, Duke Street,
London, W.1**

Telephone: MAYfair 5645

UNIVERSAL TAYLORMETERS
**74
RANGES**

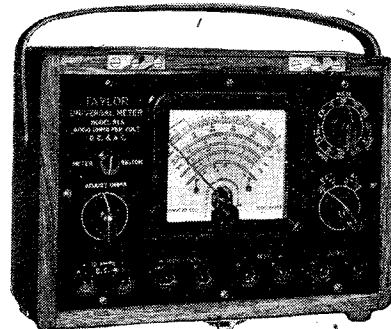

NOTE THESE IMPORTANT FEATURES:
METER. 4½" square type Taylor moving coil meter.
SCALES. There are six scales, the outer being 3½" long.

RANGES.
D.C. Volts. 0-0.1, 0-0.2, 0-2.5, 0-5, 0-10, 0-20, 0-25, 0-50, 0-100, 0-200, 0-250, 0-500, 0-1000, 0-2000.
A.C. Volts. 0-2.5, 0-5, 0-10, 0-20, 0-25, 0-50, 0-100, 0-200, 0-500, 0-1000, 0-2000.
Output. 0-25, 0-5, 0-10, 0-20, 0-25, 0-50, 0-100, 0-200, 0-250, 0-500, 0-1000, 0-2000.

D.C. Current. 0-50 micro-amp., 0-100 micro-amp., 0-1 m/a., 0-2 m/a., 0-10 m/a., 0-20 m/a., 0-100 m/a., 0-200 m/a., 0-1 amp., 0-2 amp., 0-10 amp., 0-20 amp.

A.C. Current. 0-50 micro-amp., 0-100 micro-amp., 0-25 m/a., 0-50 m/a., 0-25 amp., 0-0.5 amp., 0-2.5 amp., 0-5 amp.

Resistance. 0-1000, 0-100,000, 0-50 megohms (with internal battery), 0-1000 megohms (with external battery).

Decibels. -22 to +8, -10 to +20, -2 to +28, +10 to +40, +18 to +48, +30 to +60.
4 Adaptors available for increasing ranges.

There is no other multi-range meter in existence which has the same sensitivity on BOTH A.C. and D.C. as the Taylor

MODEL 81C
(20,000 ohms per volt)

£18-18-0
(No purchase tax payable)

Supplied complete with instruction book and 3 test leads.

MODEL 81A
£13-13-0

Sensitivity 4,000 ohms per volt, A.C. and D.C.

(No purchase tax payable).
A fully descriptive Brochure of either model is available free on request.

**BRITISH MADE AND
GUARANTEED 6 MONTHS**

TAYLOR ELECTRICAL INSTRUMENTS LTD.
419-422, Montrose Avenue, Slough, Bucks.

Phone: Slough 21381.



Ask Yourself WHY!

Within the past five years Eimac Tubes have moved into first place. Today they are in the sockets of some of the most important radio transmitters in the world. What is the reason behind this? Perhaps it is because of the extraordinary economies they bring about in day-in and day-out operation. Perhaps it is their unusual performance capabilities, their stamina and great dependability . . . or perhaps it is because Eimac tubes never fail prematurely because of gas released internally (they're guaranteed against such failures, the only tube on the market that carries such a guarantee). Chances are though, you'll find it is not any one but all these points combined that has won this recognition . . . anyway you find it, the fact remains that . . .

In the Field of Electronics, the overwhelming trend is to

**Eimac
TUBES**

Eitel-McCullough, Inc. - San Bruno, California

FOLLOW THE LEADERS IN THE FIELD OF RADIO COMMUNICATIONS

There's an Eimac tube to fit your needs from 35 watts to 2000 watts plate dissipation . . . *Get full information now!*

Foreign Division

FRAZAR & CO., LTD.

301 CLAY STREET, SAN FRANCISCO, CALIFORNIA, U. S. A.

CABLE "FRAZAR"

PREMIER RADIO

Bakelite Dielectric Variable Condensers. .0005 mfd. Suitable Tuning or Reaction. 1/6 each; .0001 and .00075, 6d. each.

Short-Wave H.F. Chokes. 10-100 m., 10½ d. each.

Pye Wound Type. 15-200 metres, 2/-.

Lissen Dual Range Screened Coils. Medium and Long Waves, 2/9 each.

Small 2 Gang. .0005 with Trimmers, 3/6; ditto

3 Gang fully screened, 5/-.

2,000 ohm, 25 watt Res with 5 Tapping Clips, 1/6.

SHORT-WAVE CONDENSERS
Trolitul insulation. Certified superior to ceramic. All-brass construction. Easily ganged.

15 m.mfd.	2/4	100 m.mfd.	3/-
25 m.mfd.	2/6	160 m.mfd.	3/7
40 m.mfd.	2/6	250 m.mfd.	4/-

ELECTROLYTIC CONDENSERS
Cardboard cases. 500 v. working, 4 mfd., 1/9; 8 mfd., 2/4; 8+8, 4/6; 4+4, 2/6; 4+4+1, 3/9; 4+4+4, 3/8; 8+4, 3/8; 16+8, 5/10; 16+16, 7/-; 25 mfd 25 volt, 1/6; 50 mfd, 12 volt, 1/6; 15 mfd. 100 volt, 1/3. Mansbridge type, 1 mfd, 250 volt, 1/-; 2 mfd. 250 volt, 1/9; 4 mfd. 500 volt, 4/8, 8 mfd. 125 volt tubular, 1/6. 1+1 Mains Buffer, 1/2.

PREMIER MICROPHONES
Transverse-Current Mike. High grade large output unit. Response 45-7,500 cycles. Low hiss level, 23/-.

Moving Coil Mike. Permanent magnet model requiring no energising. Response 90-5,200 cycles. Output .25 volt average. Excellent reproduction of speech and music. 49/-.

Microphone Transformers. Suitable for all mikes. Tapped primaries. A, 20 and 40 : 1; B, 30 and 60 : 1; C, 50 and 100 : 1, 6/6 each.

Please Note.—All Short-wave Kits include Purchase Tax.

NEW PREMIER S.W. A.C. RECEIVER
In response to many requests we have now produced an A.C. version of the popular Premier Short Wave SG3 Kit. Circuit: Pentode H.F. Stage, Pentode Detector, Pentode Output, and F.W. Rectifier. 200-250 v. A.C. Operation. Built-in Power Pack. Hum-free operation. For use with Phones or P.M. Speaker.

Complete Kit of Parts with drilled chassis, all components, Plug-in Coils covering 13-170 metres, 4 valves and full instructions **£6.14.6**

Battery Version also available Kit £4/15/4

★ "The Wireless World" said they were "very much impressed..."

See full Test Report, pp. 492-3, December issue. Send for details.

PREMIER SMOOTHING CHOKES

Type	Current	Henrys	Res.	Prices
C 40/500	40 MA	20-34 H	500 ohms	6/-
C 60/180	60 MA	8 H	180 ohms	6/-
C 60/400	60 MA	25-34 H	400 ohms	8/8
C 60/500	60 MA	18-30 H	500 ohms	8/8
C 100/400	100 MA	20-34 H	400 ohms	10/8
C 150/185	150 MA	20-34 H	185 ohms	15/4
C 200/145	200 MA	20-34 H	145 ohms	18/-
C 250/120	200 MA	25 H	120 ohms	20/-

PREMIER BATTERY CHARGERS FOR A.C. MAINS.
Westinghouse Rectification complete and ready for use.

To charge: 6 volts at 1 amp ... 26/-
2 volts at ½ amp ... 13/4 12 volts at 1 amp ... 28/-
6 volts at ½ amp ... 22/- 6 volts at 2 amp ... 43/6

ALL ENQUIRIES MUST BE ACCOMPANIED BY 2½ d. STAMP.
ALL ORDERS LESS THAN 5/- 6d. POST EXTRA.

PREMIER 1941 HIGH FIDELITY AMPLIFIER KITS

Each Kit is complete with ready drilled chassis, selected components, specially matched valves and full diagrams and instructions.

	Kit of Parts with Valves	Completely Wired and Tested
4-watt A.C. Amplifier	£8 11 6	£9 11 6
6-watt A.C. Amplifier	£8 16 6	£7 13 6
8-10-watt A.C./D.C. Amplifier	£7 9 0	£7 9 0
15-watt A.C. Amplifier	£7 18 9	£9 8 0

Black Crackle Steel Cabinet, 17/6 extra.

MAINS TRANSFORMERS
Wire-ends. All L.T. Windings Centre Tapped.

SP. 250	250-0-250 v. 60 m.a. 4 v. 1-2 a, 4 v. 2-3 a., 4 v. 2-3 a.	13/4
SP. 300	300-0-300 v. 60 m.a., 4 v. 2-3 a., 4 v. 2-3 a., 4 v. 2-3 a.	13/4
SP. 301	300-300 v. 150 m.a. 4 v. 2-3 a., 4 v. 2-3 a., 4 v. 1 a. 4 v. 1 a.	17/4
SP. 350A	350-350 v. 100 m.a. 5 v. 2 a. (not C.T.), 6.3 v. 2-3 a.	16/-
SP. 350B	350-350 v. 100 m.a. 4 v. 2-3 a., 4 v. 2-3 a., 4 v. 2-3 a.	16/-
SP. 351	350-350 v. 150 m.a. 4 v. 1-2 a., 4 v. 2-3 a., 4 v. 3-4 a.	17/4
SP. 351A	350-350-150 m.a. 4 v. 3 a., 4 v. 2-3 a., 4 v. 1 a., 4 v. 1 a.	22/-
SP. 352	350-350 v. 150 m.a., 5 v. 2 a., 6.3 v. 2 a., 6.3 v. 2 a.	18/-
SP. 811	300-300 60 m.a., 4 v. 1 a. 4 v. 5 a.	8/11

Auto Transformers. Step up or down, 100-125 v. to 200, 230 or 250 v. A.C., 60 watts, 11/4; 125 watts, 15/-; 250 watts, 22/-.

L.T. Transformers, all C.T.

4 v. 2-3 a.	11/4	6.3 v. 2-3 a.	11/4
2.5 v. 3 a.	11/4	7.5 v. 3 a.	11/4
5 v. 2-3 a.	11/4	12 v. 3-4 a.	18/-

Push-Pull Driver Transformers 6/6
Universal Output Transformers 11 Radios. Single or Push Pull 6/6
C.T. Output Transformers 4/6
Heavy Duty Type for G 12's, etc. 6/6

MATCHMAKER UNIVERSAL OUTPUT TRANSFORMERS
Will match any output valves to any speaker impedance. 11 ratios from 13 : 1 to 80 : 1. 5-7 watts, 16/10. 10-15 watts, 21/10. 20-30 watts, 36/10. 60 watts, 49/6.

PREMIER RADIO CO. ALL POST ORDERS to: JUBILEE WORKS, 167, LOWER CLAPTON ROAD, LONDON, E.5. (Amherst 4723).
CALLERS to: Jubilee Works, or 169, Fleet Street, E.C.4 (Central 2833), or 50, High Street, Clapham, S.W.4. (Macaulay 2381.)

Treat yourself to this new radio experience.....

If it hadn't been for the war, you might to-day be the proud owner of a new radio—enjoying a fresh thrill from your listening. Well, here's an idea. For a fraction of the cost of a new set you can get one of the latest Stentorian Extension Speakers. Install it in any room you like and then listen critically. The fine balance of tone, the vivid clarity of reproduction will delight you.

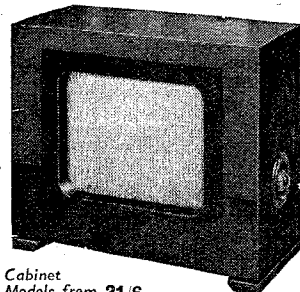

It will give you a fresh interest to your listening and a new pride in your home.

Ask your dealer for a demonstration.

Cabinet Models from 21/6



Stentorian

THE PERFECT EXTRA SPEAKER FOR ANY SET

WHITELEY ELECTRICAL RADIO CO. LTD., MANSFIELD, NOTTS.

M.R. SUPPLIES

continue to offer from stock brand new **ELECTRO-TECHNICAL EQUIPMENT** of the highest specification, for **INDUSTRIAL RESEARCH** and **DOMESTIC** purposes. You save delay and disappointment by studying our monthly announcements in this journal.

BATTERY CHARGING EQUIPMENT. One of our most appreciated offers. **METAL RECTIFIERS** (prominent British maker), D.C. delivery 12/14 volts at 6 amps, 33/6. Also new big output model, 12/14 v. at 10 amps, 42/-.

Step-down MAINS TRANSFORMERS for 6-amp. model only. Prim. 200/250 v. (tapped) and Secondary tapped for 6 and 12 v. charging at 5/6 amps, specially designed for use with that rectifier and solidly made, 35/-.

Transformers for 10-amp. model available later. **PLEASE NOTE**—Owing to scarcity and cost of packing material, we now have to charge 1/9 for packing and postage on any of above items. Also same make of **RECTIFIERS, D.C. del. 12/14 v. at 1.5 amps, 10/9. TRANSFORMERS** to suit, Prim. 200/250 v. (tapped) and Sec. 7, 11 and 15 v. 2 amps, 11/6. **SLIDING RHEOSTATS.** Fully enclosed, with brushed cable entries. Suits for use with laminated brush contacts. Continuously rated, 4 ohms 5 amps., 10 ohms 3 amps., 50 ohms 1.7 amps., 100 ohms 1 amp., 200 ohms 7 amp., 400 ohms 5 amp., either one, 14/6. Also 375 ohms 1 amp., with QMB switch, 34/6.

SPECIAL PRECISION ELECTRIC CLOCK MOVEMENTS. Synchronous, 200/250 v. 50 c., fitted spindles for seconds, minutes and hours. For factory, laboratory and public clocks, recording drums, etc. These are fitted with an auxiliary motor for starting and re-setting clock, very useful for short-period operation timing by means of seconds hand. Capable of driving clocks up to 4ft. diameter, 49/6.

REDUCTION GEAR MOTORS. Operation 15/25 v. A.C., final speed 60 r.p.m. Reversible, with auto 2-make switch. For radio tuning, recording instruments, contact making, etc. final offer, 8/6. Also last few of very high torque model, operation 200/250 v. A.C., final speed 3 r.p.m. Real precision instruments, invaluable in research depots., 25/-.

Also a few of latter, fully enclosed and fitted 3in. turntable, 35/-.

ROTHERMEL NEW JUNIOR PIEZO-CRYSTAL PICKUPS, performance equal to the other well-known models (no longer available) but less expensive arm and pivot assembly. Completely recommended, 28/6 (inc. P.T.).

PHILIPS' P.M. M/COIL SPEAKERS. High efficiency model of very handy size, only 7in. dia., fitted high-flux alni magnet. 3 ohms imp. Ideal ext. speaker, 16/6. (Appropriate multi-ratio transformer, if required, 3/6 extra.) **MINIATURE P.M. M/COIL MICROPHONE/SPEAKER UNITS.** Performance equal to most expensive mic. mikes, impedance 12 ohms. Ideal for inter-communication systems and P.A., 13/6. (Suitable transformer, if used as mike or speaker, 5/6.)

G.E.C. HIGH-FIDELITY MICROPHONES. Model 1575—list £7 10s. Reisz type in solid polished bronze case, with suspension lugs. Linear response. Last few, brand new, perfect, 47/6.

ELECTRO-MAGNETIC COUNTERS. Coil res. 500 ohms, counting up to 9,999. Many industrial and domestic applications (Ex-G.P.O., all perfect), 5/6.

MAINS TRANSFORMERS for amplifiers, radio, etc. Prim. 200/250 v. Secs. 400-0-400 v. 200 m.a., 4 v. 5 a., 4 v. 7 a., and 4 v. 8 a., 39/6. Also same Prim. and H.T., but 6.3 v. 6 a., 6.3 v. 6 a., and 5 v. 2 a., 42/6. Cannot replace present stock—only a few.

L.T. SMOOTHING CHOKES, Ind. 75 h. at 1 amp., 4/11. **L.T. SMOOTHING CONDENSERS** (T.C.C.), 1,000 mfd. 15 v. wkg. 3/11. **L.F. CHOKES,** 15 h. 75 m.a. (Res. 500 ohms), 8/11. 20 h. 100 m.a. (Res. 100 ohms), 8/6.

PIEZO-CRYSTAL ELEMENTS (Rothermel Brush) for construction of mike, tweeter, contact mike, piano repeater, etc., scientifically interesting, 2in. dia., fitted stylus, 6/11.

MERCURY SWITCHES, s.p.c.o., 6 gmpa., 4/6. "ARROW" **TOGGLE SWITCHES,** 3 amp. on-off, 1/9 ea., 18/6 doz. **MORSE KEYS,** copy of Govt. patt., adjustable plated action on baseboard, 3/11.

Stocks obviously limited—order now with every confidence.

M.R. SUPPLIES, 68, New Oxford St., London, W.C.1
Telephone: MUSEum 2958

F R E Q U E N T I T E

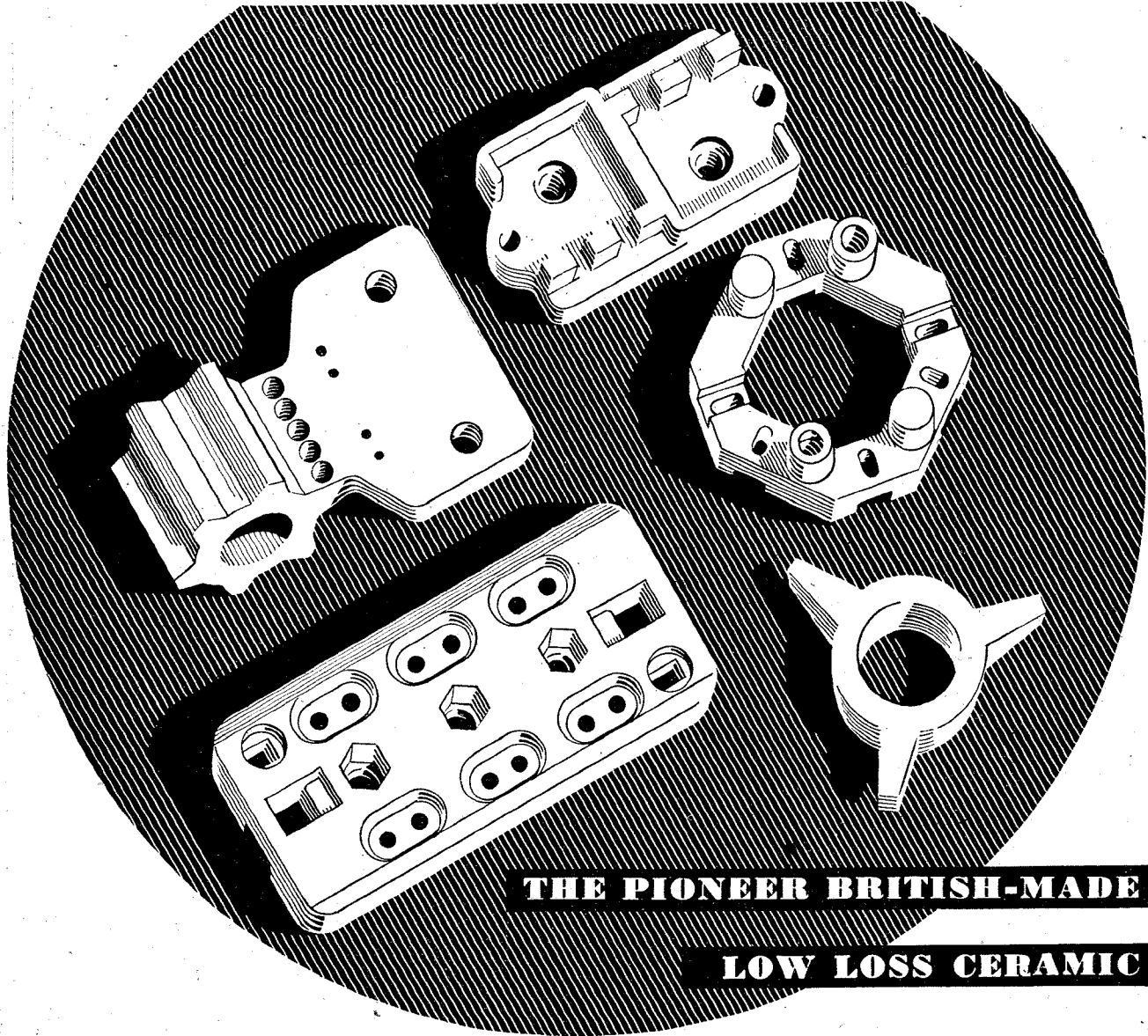

THE outstanding properties of Frequentite—Low Loss and High Mechanical Strength—led to a demand which even before the war severely taxed our productive capacity. The needs of the fighting services have inevitably led to restriction in supplies for general industry, *but we can now meet all requirements promptly.*

Extensions to our plant, the employment of specialised new equipment, and progressive improvements in our manufacturing technique made during the past seven years, now enable manufacturers to obtain bulk supplies of the most intricate designs. Please write for Catalogue No. SP.10.

STEATITE & PORCELAIN PRODUCTS LTD.

Head Office and Works: STOURPORT-ON-SEVERN, WORCS.
Telephone: Stourport 111. Telegrams: Steatint, Stourport.

SP2

RAYMART

CRAFT A CREED

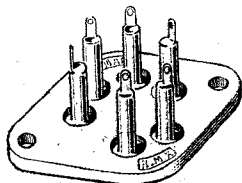

Occasionally, however, we "guess wrong." We produced a 6-pin Former with pin spacing to fit a standard 7-pin Valveholder, our idea being that the user could then at a reasonable price purchase a good Ceramic Valveholder and not spoil the efficiency of his Coil by fitting it into a poor Holder. The experiment quite frankly failed, largely we believe because the other 6-pin arrangement appeared to be standardised and also that many had some Coils on this type Former already.

There is an old adage—"If Mahomet can't get to the mountain, the mountain must be brought to Mahomet," so we've produced an RMX Ceramic Coil Holder to fit your 6-pin Coils. Here is a plan drawing of it. Try your Coils on it and then scrap your high loss Holders. The price? only 1/6 with sterling silver plated sockets, probably less than you paid for your bakelite one, and delivery at the moment—Ex Stock.

RAYMART

CRAFT A CREED

IMPROVING THE BREED

Since the inception of "Raymart" the consistent policy of the Company has been to produce a better Component. The motto of "Craft a Creed" incorporated in our trade mark is kept before us always.

Pioneers of quality short-wave materials at sane prices we have pioneered many innovations amongst which are Microvariable Condensers with RMX Ceramic endplates, Electrically shorted ball races in Condensers, increased range of Insulators, parasitic Filters, improved Coils on thin formers raising "Q" of Coils by removing insulation from field, etc., etc.

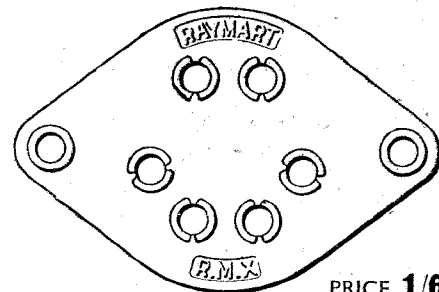

PRICE 1/6

We also manufacture the most comprehensive range of Communication Equipment, Components for Transmitters, Receivers, Oscilloscopes, etc., etc.

44 & 48 HOLLOWAY HEAD, BIRMINGHAM, 1. Phone: Midland 3254

Quicker and Better than a Re-wind

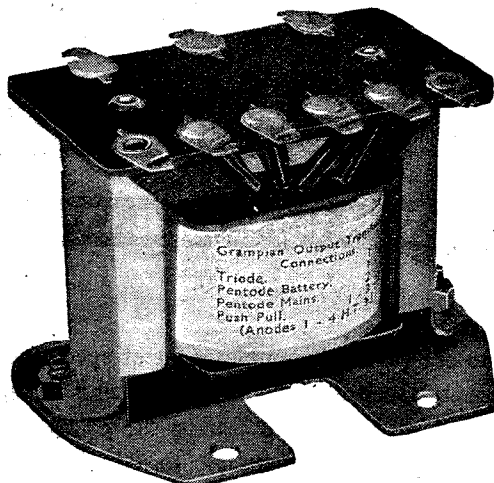

All this is prompted by the desire to help dealers, by ensuring that every Unit is as reliable as human skill, and experience can make it. A component which enables you adequately to cope with the multiplicity of Valve Types in use today.

Here is a pedigree component which is available at less than re-wind cost. 6/- each. Conveniently packed. Display box of 6 from all Factors and Wholesalers.

The new Gram pian All-ratio Output Transformer provides 8 Ratios to suit any standard speech coil impedance. Tapped primary and secondary ensure more exact matching than any other similar model. Primary is tapped for Triode, Battery, Pentode. Mains Pentode and Push-pull Output. Secondary is tapped for 2 ohms and 9 ohms speech coil. Universal fixing plate.

GRAMPIAN REPRODUCERS LIMITED
KEW GARDENS, SURREY ————— Phone: RICHMOND 1175/6/7

RADIOLOCATION!

The word should have been coined for the new EDDYSTONE 358 Communication Receiver ; instead, it has come to represent to the man in the street the latest developments in radio technique applied to locating hostile aircraft, U-boats, etc.

For "Radiolocation" of those long distance "Difficult-to-Receive" Short Wave Stations for the reception of which precision instruments only are of use, the Eddystone "358," like the famous lighthouse, represent a landmark in Communication Receiver design. It is ruggedly built, British to the core, and our engineers have incorporated every advanced detail to assure that performance shall be equal to present-day tasks.

Outstanding Features.

32 M/cs. to 120 K/cs.
Accurate calibration.
High sensitivity. Very high signal-to-noise.
Logging scale. All-circuit meter. Separate power pack.

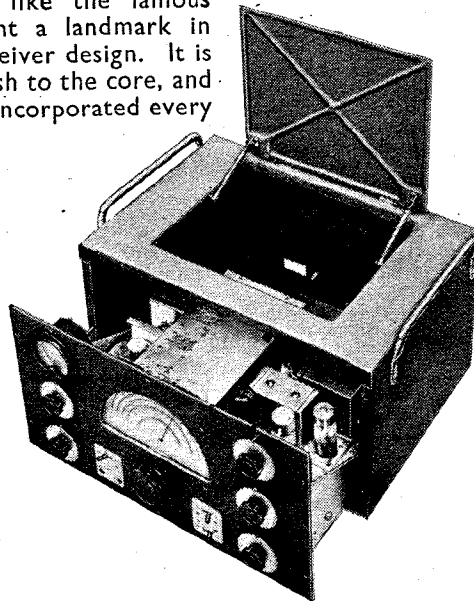

EDDYSTONE components and Receivers have for some time been difficult to obtain. The demand is still colossal, mainly from Government Departments, but we have overcome most of our wartime set-backs and have now in ENERGETIC PRODUCTION a range of components to meet most requirements. This range is being added to quickly. The "358" and its counterpart medium frequency model "400" with or without band-pass crystal filters are available for

WORK OF NATIONAL IMPORTANCE

WEBB'S RADIO

14, SOHO STREET, OXFORD STREET, LONDON, W.1
OPEN 9 a.m. to 6 p.m. ; SATS. 1 o'clock. 'PHONE : GERRARD 2089

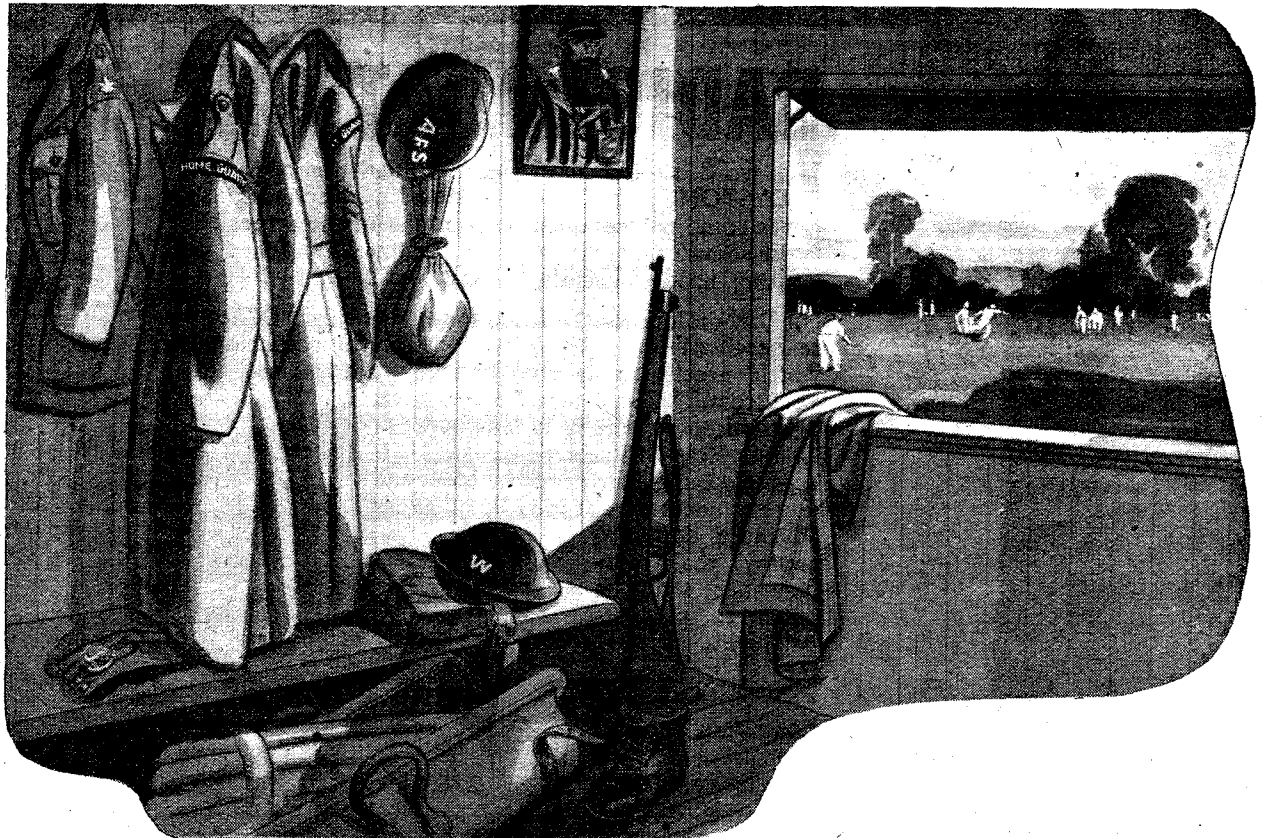

ADAPTABILITY

The amazing adaptability of Simmonds Speed Nuts enables manufacturers to speed up production on practically every type of assembly. From our range of over 600 types of Speed Nuts there are probably several which can simplify your production operations and accelerate output. Study the selection shown on this page in the light of your present assembly procedure.

If you have an assembly problem where the time taken is hampering output, we will be very glad to co-operate with a view to effecting economies in time and cost.

Simmonds
Speed Nuts
(PATENTS APPLIED FOR)

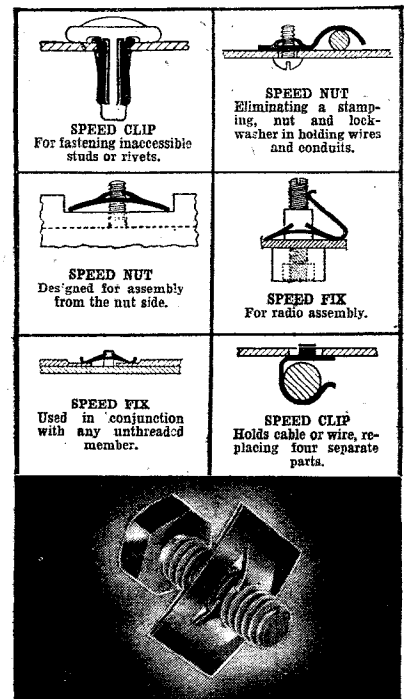

SIA SIMMONDS AEROCESSORIES LTD **SIA**
GREAT WEST ROAD, LONDON.

The Wireless World

31st
Year of Publication
Covering Every Wireless Interest
AUGUST 1941

Proprietors:
ILIFFE & SONS LTD.

Editor:
HUGH S. POCOCK.

Editorial, Advertising
and Publishing Offices:
DORSET HOUSE,
STAMFORD STREET,
LONDON, S.E.1.

Telephone:
Waterloo 3333 (35 lines).
Telegrams:
"Ethaworld, Sedist, London."

△

**PUBLISHED
MONTHLY**

Price: One Shilling

(Publication date 20th
of preceding month)

Subscription Rates
Home and Abroad
14/- per annum

EDITORIAL	199
MINIMISING SELECTIVE FADING. By L. A. Moxon, B.Sc., A.C.G.I.	200
THE "PERSONAL" RECEIVER	203
LETTERS TO THE EDITOR	205
DESIGNING SMALL PORTABLES. By S. W. Amos, B.Sc. (Hons.)	206
MORE MAKESHIFTS. By W. H. Cazaly	208
THE WORLD OF WIRELESS	211
NEWS IN ENGLISH FROM ABROAD	213
SERVICING EQUIPMENT AND ITS USES, Part II. By "Service"	214
RANDOM RADIATIONS. By "Diallist"	218
UNBIASED. By Free Grid	219
RECENT INVENTIONS	220

Branch Offices:

COVENTRY:
8-10, Corporation Street.
Telephone: Coventry 5210.
Telegrams: "Autocar, Coventry."

BIRMINGHAM:
Guildhall Buildings,
Navigation Street, 2.
Telephone:
Midland 2971 (5 lines).
Telegrams:
"Autopress, Birmingham."

MANCHESTER:
260, Deansgate, 3.
Telephone:
Blackfriars 4412 (4 lines).
Telegrams:
"Iliffe, Manchester."

GLASGOW:
26B, Renfield Street, C.2.
Telephone: Central 4857.
Telegrams: "Iliffe, Glasgow."

△

*As many of the circuits and
apparatus described in these
pages are covered by patents,
readers are advised, before
making use of them, to satisfy
themselves that they would
not be infringing patents.*

Masteradio

INTRODUCE THE NEW "SILENT SURGE" VIBRATORPACK

Described by the "Wireless World" as "A considerable step forward," Masteradio Vibratorpacks incorporating the patented "Silent Surge" circuit, give remarkably Noise-Free operation on sensitive Communication type Receivers on any frequency.

Obtainable for operating from 6 and 12 volt D.C. supplies with outputs of up to 20 watts.

This vital circuit is employed exclusively by Masteradio Ltd. and has been developed for use with highly sensitive Communication type Receivers operating on all frequencies. It has been tested with many well-known makes with complete satisfaction.

The new Vibratorpack is self-contained in a Cadmium Plated Steel Case measuring 8 $\frac{3}{4}$ " x 4 $\frac{3}{4}$ " x 5 $\frac{3}{4}$ " high, weighs approx. 8 $\frac{1}{2}$ lbs., and is therefore completely portable.

Write for
full details
to:—

MASTERADIO LTD. "VIBRANT" WORKS RICKMANSWORTH RD., WATFORD, Herts.
Grams: MASTIOLA. Phones: WATFORD 9885/9890.

Greenwood



Exide BATTERIES

'Still keep going when the rest have stopped'

THE CHLORIDE ELECTRICAL STORAGE COMPANY LTD.

(Exide and Drydex Batteries) Grosvenor Gardens House, Grosvenor Gardens, London, S.W.1

Telephone: VICTORIA 2299. Telegrams: Chloridic, Sowest, London.

FS2615

The Wireless World

COVERING EVERY
WIRELESS INTEREST

ESTABLISHED
1911

Vol. XLVII. No. 1070

AUGUST, 1941

Price One Shilling

* Radiolocation

A Major Wireless Contribution to the War Effort

JUST after the July issue of *The Wireless World* went to press the veil that has guarded the best-kept secret of the war was partially lifted. It was then disclosed that a new radio technique was being employed for the location of enemy aircraft.

Here, it would seem, is an answer to the question of how the Royal Air Force was able last summer to beat off so successfully and competently the mass daylight attacks of the numerically superior *Luftwaffe*. At any rate, wireless in its various forms must have been largely responsible for our success. The older and well-known methods of communication operate more powerfully in favour of the defence than of the offence, and, in conjunction with the new technique of "radiolocation," may well have been a deciding factor in the winning of the Battle of Britain. Radiolocation helped us to concentrate our fighter aircraft at tactical points for meeting attacks and prevented extravagant dispersal. It also reduced the need for constant patrolling, with its inevitable wastage of men and machines. Truly, wireless has no cause to be ashamed of its latest contributions to the war effort.

Reflected Waves

What is radiolocation? Reams have been written on it in the lay Press, but, so far as wireless men are concerned, all that can usefully be said about it at present is that it depends for its action on the reflection of electro-magnetic waves from solids (conductors, semi-conductors or insulators). The obvious advantage over conventional means of wireless direction finding, etc., is that it does not depend on emissions from the object (enemy aircraft, etc.) to be located; the exploratory waves to be reflected are under our own control.

The reason why even this meagre amount of information has been disclosed is clear. Men are

required in increasing numbers to develop the apparatus, to operate it, and to maintain it. The supply of wireless recruits in this country is not unlimited, and it became necessary to issue an appeal for technicians in the United States. The chance of success of such an appeal was obviously greatly increased by the publicity given to the disclosure of information on our "secret weapon."

Opportunities to Help

The fact that an appeal for American help was necessary gives grounds for serious thoughts among wireless men in this country. It is galling to us to depend on outside aid to a greater extent than is essential in a matter of such importance, and we hope that a supreme effort will be made to tap our admittedly dwindling reserves of suitable manpower. There must be many readers of this journal with knowledge and experience that would fit them for one of the many branches of radiolocation. It is a matter for their own consciences to decide whether their present work is more important. Unless fully convinced that it is, they should offer their services for radiolocation, putting their qualifications fully and frankly before the authorities. Readers in the Forces are reminded that applications for transfer can be made through the usual Service channels.

Unless radiolocation proves to differ greatly from similar branches of our art with which it can be compared, it will in the early stages depend largely for its success on the human element. The right kind of men are wanted, and wanted quickly. For development engineers the scientific attitude towards new problems and methods is more important than long practical training. Operators and maintenance men should be used to thinking for themselves instead of slavishly "following the book."

Minimising Selective Fading

By L. A. MOXON, B.Sc., A.C.G.I.

NEARLY everyone is familiar with the unpleasant effects of selective fading. The appalling distortion which occurs when, for instance, the carrier fades out and leaves the sidebands behind will be specially familiar to SW listeners.

This article concerns some experiments recently started with a view to reducing the annoyance caused by this

complete absence of wave. This cancellation will only take place at one wavelength, so that it is possible for the carrier to disappear while the sidebands remain, and the effect on quality of reproduction is catastrophic. It is usually of short duration owing to variations of paths.

With large differences in path length quite a small change in wavelength

An Experimental Attack on the Problem

An Experimental Attack on the Problem

arriving from two widely different directions a simple frame aerial is effective. This is often the case when two synchronised transmitters are being used, an arrangement which tends to cause selective fading by creating differences of path length.

Selective fading is often due to interference between ground and reflected waves, and this also may yield to some extent to the frame aerial treatment, the ground wave being fairly easy to eliminate. In any case of selective fading involving short distances, it seems a likely assumption that if the path lengths are sufficiently different to be troublesome, there will be a substantial difference in angle of arrival which may enable a frame to function.

At the long distances involved on short waves, the problem is very different. The MUSA or Multiple Unit Steerable Antenna system will be recalled by *Wireless World* readers. This very interesting system employs a number of diamond aerial arrays suitably phased, and enables reception to be confined to a very narrow angle which can be adjusted to suit conditions. Involving over 1,000 valves and some miles of aerial, its applications are obviously limited.

We will now consider the possibili-

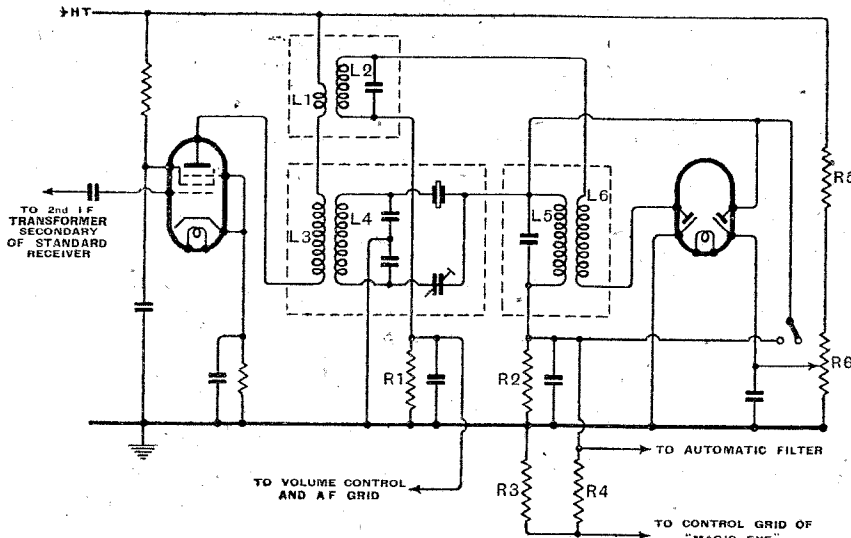

Fig. 1. Carrier boosting circuit. Values of components: L1, small 8-turn coupling coil; L2, 90 μ H, shunted by 1350 μ F; L3, L4, L5, L6, 860 μ H; R1, 0.2 megohm; R2, 0.5 megohm; R3, R4, 2 megohms; R5, 50,000 ohms; R6, 10,000 ohms.

type of fading. Although completion of the work has had to be postponed, some interesting results have been obtained.

Let us examine the problem. An ordinary amplitude-modulated signal comprises a carrier and sidebands. Distortionless reproduction involves maintaining the initial phase and amplitude relationships of the sidebands to the carrier. Now let us consider a signal arriving at the receiver by two or more paths of different length. The signal arriving by one path will be different in phase to that arriving by the other, and the result may be an addition or subtraction of the two parts. For example, if there are two equally efficient paths differing in length by half a wavelength, or any odd number of half wavelengths, the trough of the wave arriving by one path will coincide with the crest of the other. The crest will fill the trough and the result will be a com-

plete absence of wave. This cancellation can make the difference between addition and subtraction, so that the fading of the carrier may even be accompanied by a boost of the sidebands. With small differences of path length a carrier fade will be accompanied by a very similar fade of the sidebands as well, and unless the carrier disappears completely distortion will not be evident. The process is really more complicated than this since different frequencies tend to prefer different routes, and the length and efficiency of paths is constantly changing, but the explanation given may be found helpful.

There appear to be two possible lines of attack on the problem: (1) restricting propagation or reception to a single path, and (2) restoring workable relationships between the various side band components and the carrier, in the receiver.

With regard to the possibilities of single-path reception, if the signal is

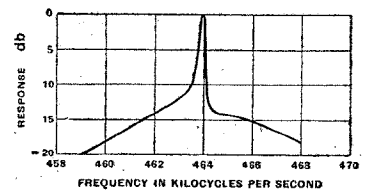

Fig. 2. Carrier attenuation: measured response obtained with circuit of Fig. 1.

ties of carrier restoration. The amount of harmonic distortion caused by disturbance of the phase and amplitude relations of carrier and sidebands depends on the percentage modulation. If this is low, the relationships are relatively unimportant. Fig. 1 is a circuit arrangement for using a quartz crystal to boost the carrier and reduce the percentage modulation. It is

adaptable to any receiver having an IF of 465 kc/s or thereabouts, and the principle is as follows. Sideband and carrier voltages exist across L2 and carrier only across L6. The sum of these voltages is applied to the signal

The impression was formed that exaggeration of high frequencies during a selective fade was at least as unpleasant as the harmonic distortion. On the assumption that distortion was worst when the carrier faded, a top

cut would be the case during an ordinary fade, and since it is used, after selection by the crystal; to control the filter, the top cutting is more likely to take place during a selective than an ordinary fade. If it does happen at the wrong time, the result is less irritating than the alternative distortion; further, top cutting during a severe amplitude fade has the advantage of reducing the noise level.

For producing the top cut, automatic variable selectivity may be suggested as an improvement over the filter. It involves much more complication, but would have the advantage that it cuts top in the best possible way; that is, by reducing the modulation percentage after this has been increased by the selective fade.

Observations were at first made entirely on short waves, owing to the absence of suitable MW signals. It was very difficult to make reliable observations owing to the erratic nature and brief duration of selective fades. Even the quickest change-over test was apt to be misleading, and the reliable observation of small improvements was quite impossible. To this end a controllable test signal seemed very desirable, and the bridge circuit of Fig. 5 was devised.

Regarding selective fading as the balance of one voltage against another and dependent on frequency, it will be seen that this bridge circuit should have a similar effect on the signal ap-

Fig. 3. Voltage-controlled circuit for attenuating high notes. V is the AF valve of a standard receiver.

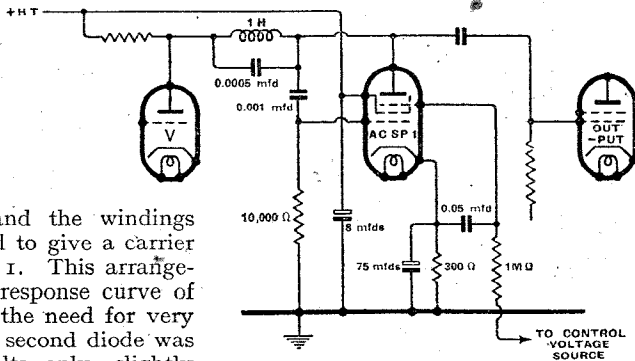

cut controlled by the carrier seemed to be the next step. The circuit of Fig. 3 was set up, in which a valve acting as a variable capacity controlled the cut-off frequency of a simple low-pass filter. This was arranged to vary the AF response between the limits shown in Fig. 4. By supplying control volts from the second diode (Fig. 1) it was arranged to cut top whenever the carrier faded below a predetermined level controlled by the delay on the diode.

Used by itself, this circuit also gave rather inconclusive results, but in conjunction with carrier restoration a marked improvement was often observable. At least three criticisms of this scheme are possible: (1) The adjustment of the delay is critical. (2) It assumes that selective fading always takes place at the same carrier level. (3) It does not appear to distinguish be-

(left-hand) diode, and the windings may be proportioned to give a carrier boost of about 5 to 1. This arrangement produced the response curve of Fig. 2. In view of the need for very accurate tuning, the second diode was fed with carrier volts only, slightly delayed, and used to control a "magic eye" tuning indicator. The output of this diode was also available for controlling the automatic filter described later. A switch was provided to cut out the crystal circuit for the purpose of comparative tests. This simple crystal filter was not found selective enough to boost the carrier alone, and it also accentuated the lower modulation frequencies. This did not affect its working as selective distortion of the lower frequencies is slight, but it was found desirable to introduce a compensating bass cut by reducing the value of the AF coupling condenser.

Ideally, a carrier boost of greater than 5 to 1 would be desirable, but it involves some practical snags. Adjustment becomes more difficult, and elaborate bass compensation is required.

This arrangement was inserted in a standard receiver and listening tests carried out. On short wave signals it seemed to show some improvement, but observations were a little inconclusive. There were no suitable medium-wave test signals available at this time.

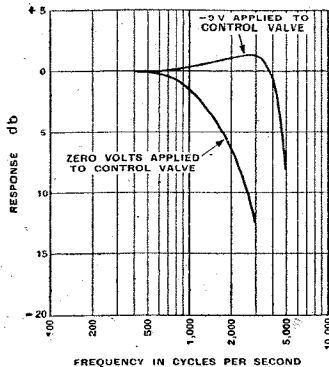

Fig. 4. Response of valve-controlled filter.

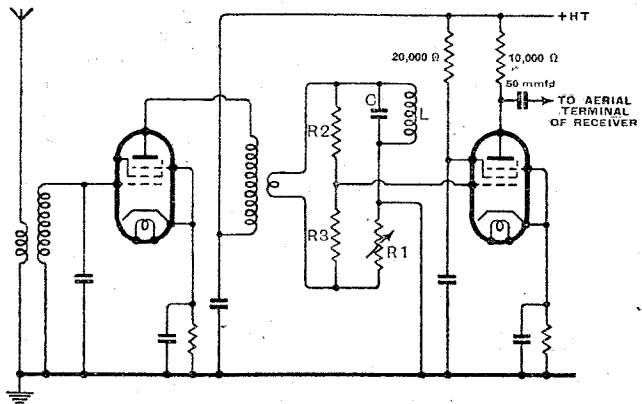

Fig. 5. Circuit for producing artificial selective fading.

tween selective and ordinary fades. There are, however, a number of extenuating circumstances. As the magic eye is controlled by the carrier it is possible to synchronise the operation of the tone control with the fading, by observation. If the carrier partially fades, leaving the sidebands at full strength, these will to some extent supply AVC and restrict the rise in sensitivity of the receiver. The carrier voltage at the point from which AVC is taken is thereby reduced more

plied to it. At its resonant frequency the circuit LC looks like a pure resistance of value, let us say, R_0 ohms, where R_0 is the product of the circuit magnification or Q , and the reactance of the inductance or capacity (ωL or $1/\omega C$). Balance requires $\omega L = 1/\omega C$ and $\frac{R_0}{R_1} = \frac{R_2}{R_3}$ and can be achieved by adjustment of R_1 and C . Fig. 6 shows a typical response as measured.

Minimising Selective Fading—

Signals from the local station were fed to the receiver through the bridge network, and a most convincing imitation of selective fading was obtainable by careful adjustment. Distortion was worst when the carrier was suppressed, and it was possible to make speech completely unintelligible. Small changes of C reduced distortion and changed the pitch of the reproduction.

On aural test the crystal appeared to be a complete cure for the artificial fade. This has not been fully explained. Such results would be expected if the crystal exactly compensated the response of the bridge, and if the phase distortion introduced by the latter was negligible. Graphical investigation shows that the phase distortion would not exceed 15 per cent. with the bridge as used. This is not serious. On the other hand, from

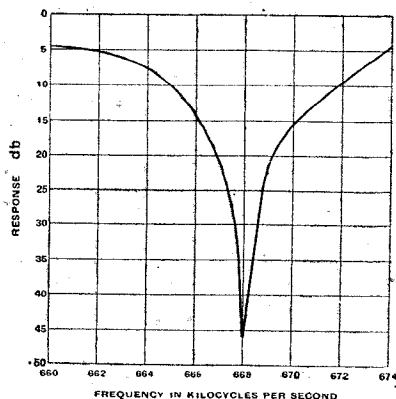

Fig. 6. Measured response of artificial fading bridge shown in Fig. 5.

comparison of Figs. 2 and 6, only partial restoration of the carrier and noticeable emphasis of the higher frequency sidebands would be expected. It is possible that Fig. 6 represents a more accurate balance than was obtained during tests, the adjustment being very critical. If the carrier was boosted sufficiently to keep the modulation below 100 per cent., harmonic distortion would not be serious with the small phase shifts given by the bridge. It is worth note that larger phase shifts, up to nearly 90 deg., can be produced by making R_2 and R_3 large compared with R_1 and R_3 .

Difference in phase shift would account for some discrepancy between real and the artificial selective fading, but leaves the difference in frequency distortion unexplained. One explanation is suggested by Fig. 7.

It has already been shown that if a signal arrives at equal strength by two paths, one of which is N wavelengths

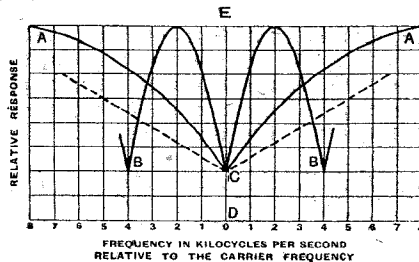

Fig. 7. Showing cancellation of frequencies near the carrier frequency for large and small assumed differences in path length. Difference of 75 kilometres gives BCB; 18.75 km. gives ACA.

long and the other M wavelengths, and if $2(N-M)$ is an odd number, the carrier will disappear. It can be further shown that if λ is the wavelength in metres of the signal to which this happens, then at a frequency

$$f_m = \frac{3 \times 10^8}{2(N-M)\lambda} \text{ cycles}$$

the waves arriving by the two paths will be in phase and add together. For intermediate values of frequency the resultant of the two paths can be found from a sine curve joining the extremes. This enables Fig. 7 to be estimated, taking the point C as zero. The curve ACA represents a small value of $(N-M)\lambda$ or difference in path length, and BCB a large difference. With complete cancellation of the carrier, distortion will be more or less equally severe in the two cases, but this is a most unlikely state of affairs. The condition of partial balance can be roughly represented by taking a new zero at D. The experimental curve (Fig. 6) for the artificial fader is also shown for reference. Fig. 7 illustrates the accentuation of the sideband frequencies; the corresponding audio responses, taking $AE=4CD$ as a typical example, and using 1,000 cycles as a reference frequency,

Fig. 8. Audio responses derived from Fig. 7. Small path difference, AA; large path difference, BB; artificial fader CC

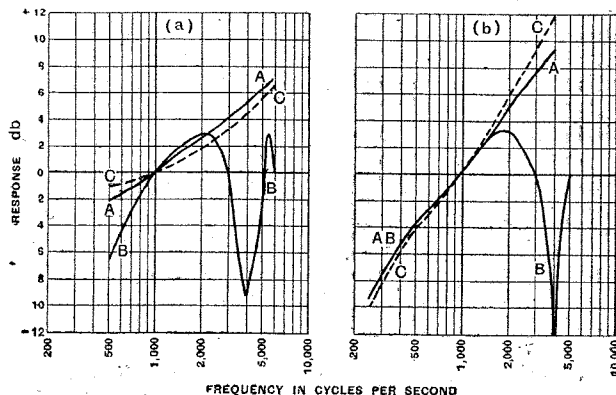

are plotted in Fig. 8 (a). The hypothetical case of $CD=0$ is plotted in Fig. 8 (b). It will be clear that frequency distortion is only severe if $(N-M)\lambda$ is large, or CD small. The former condition will be quite normal on SW, but it is not simulated

by the artificial fader. It tends to give a much more peaky response curve than the latter, and in extreme cases the production of several peaks appears possible. The advantage of limiting frequency response is likely to be greater than with the smoother curves given by the artificial fader or small path differences, especially as these tend to be corrected by the crystal circuit according to the response curve illustrated in Fig. 2.

With large values of path difference, it can be shown that the frequency distortion is accompanied by large phase shifts which accentuate the harmonic distortion. This confirms the observation that a combination of carrier boost and top cutting is essential to make any impression on SW selective fading.

At a late but opportune stage in these experiments the B.B.C. Home Service obliged with some selective fading, and observations were made. Carrier boosting appeared much more effective than on SW, but less so than on the artificial fading. This result was to be expected on the assumption of a smaller difference in path length than that usually obtaining on SW.

Except in extreme cases, ordinary fading can be cured by good AVC. Unfortunately this measure makes selective fading sound worse, because the fading of the carrier increases the sensitivity of the receiver so that the detector receives a full strength, heavily overmodulated, and phase and frequency distorted signal. The result is a loud burst of harsh and unintelligible sound in place of a well-timed reduction in volume.

It is hoped that the foregoing, which

makes no claim to being a thorough investigation, may stimulate further thought, in an interesting direction. The writer is indebted to Murphy Radio, Ltd., for permission to publish results of work carried out in their laboratory.

The "Personal" Receiver

Commercial Development of the Type in America

POCKET wireless sets have been a perennial source of interest since the early days of broadcasting, and many amateur and professional designs have been described from time to time in this journal, together with accounts of various schemes for providing the police and other services with really miniature receivers.

In America, too, the idea has been kept alive for many years, but it is not until recently that a general public demand has developed for this type of receiver. As the result of the enterprise of a number of manufacturers,

45 volts HT and 180 milliwatts with 67.5 volts.

These valves are of very small dimensions, and their production has provided the incentive to manufacture other special components of reduced dimensions. The valves are made without the usual bakelite base and wire pins are sealed directly into the glass "button" at the foot of the valve. Special holders are used, and in the case of the frequency changer and IF stages these are generally of the shock-proof type to reduce microphony.

The half-wave rectifier valve generally employed in personal sets is the 35Z5. This is only slightly larger than the receiving valves, and is fitted on a standard small octal base.

The two-ganged tuning condenser occupies no more space than a single section of the standard type of condenser used in an ordinary table model receiver. The spacing between the plates is only 0.008in. Fixed condensers of all types have also been reduced in size, and the midget paper tubulars make use of paper only 0.0003in. thick. They are rated for 120 volts working. Three-section electrolytic condensers with etched plates have capacities on the high voltage side of 20-60 mfd., and on the low tension side for filament by-passing of 100 to 200 mfd. The size of the complete condenser is about the same as that of an 8 mfd. 450 volt standard dry electrolytic.

To conserve space IF transformers

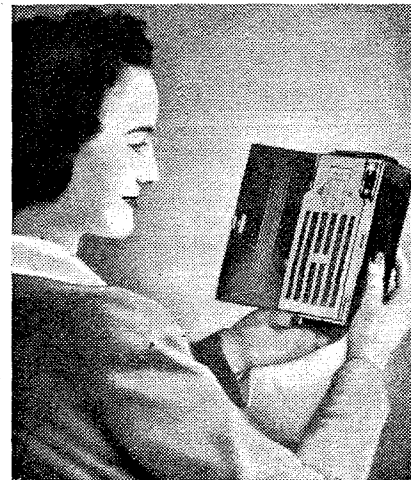

are of the "potted" type in which the powdered iron core completely surrounds the coil. Although only about $\frac{3}{8}$ in. diameter, the performance is said to be equal to that of standard range IF transformers; the Q of the circuit varies from 80 to 100. To give greater flexibility in layout the trimmers are usually mounted separately from the transformer. One obvious advantage of the potted form of construction is that the external field is reduced to a minimum, and very little screening is necessary.

The problems of switching the filaments in series for mains operation and in parallel for battery working has resulted in the development of special wafer switches, usually operated by means of a lever, thus saving valuable depth.

Loudspeakers are of the permanent magnet type with diaphragms of an average diameter of between 3 and



Valves used in American personal receivers have 1.4 volt filaments taking 50 or 100 mA. Separate bases are dispensed with and extensions of the electrode supports serve as base pins.

the attractions of the small battery pocket receiver have been combined with the popular AC/DC midget. Problems of ventilation and heat dissipation have been satisfactorily solved, and a new range of components has been developed specially for incorporation in these sets.

From a review of a number of the leading makes of this new type of set appearing in a recent issue of *Communications*, it would appear that the adoption of the superhet circuit is universal. There are usually four valves plus rectifier, and the types used are the 1R5 pentagrid as frequency changer, 1T4 variable-mu pentode as IF amplifier, 1S5 single-diode-pentode as signal and AVC rectifier and first AF amplifier (usually with high resistance grid leak bias), and 1S4 power pentode in the output stage. The output of this valve is 65 milliwatts with

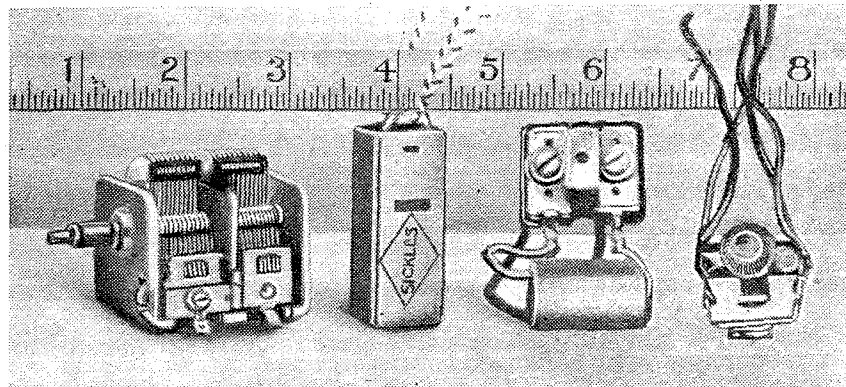

A few of the miniature components designed specially for the new portables.

The "Personal" Receiver

4 in., although some types in course of development have elliptical cones 3 in. x 2 in. Alnico magnets are used and weigh from 1½ to 4 oz. Curiously enough, the output transformers have not been greatly reduced in size, the reason being that efficiency is important

Chassis assembly of the RCA Victor personal receiver.

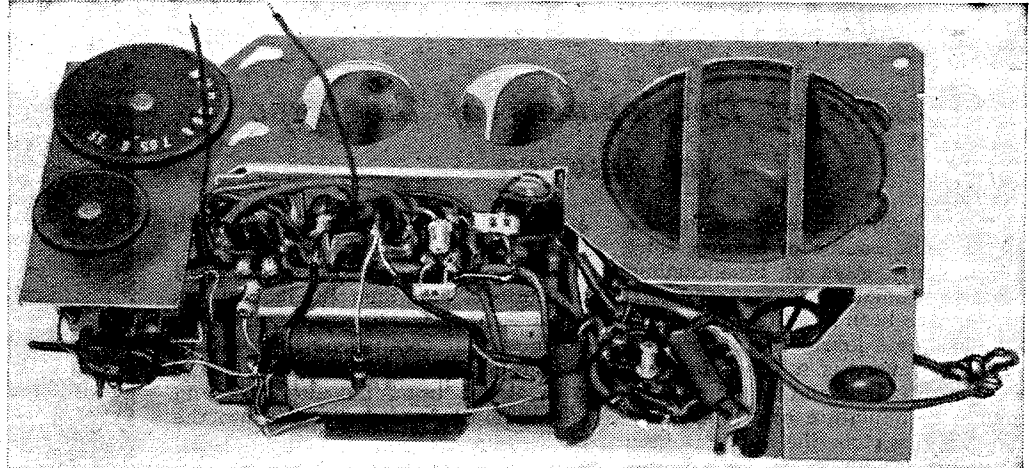

in order to conserve the small power output available from the final stage.

High tension batteries are either of the 45-volt standard midget type, or the newly developed Ever Ready Type 467 "Mini-Max." This battery has an initial voltage of 67.5 and will deliver from 8 to 11 mA for 40 to 50 hours. Standard flash light cells are used for filament heating. In the smallest 3½ to 4 lb. sets a single cell gives from 3 to 5 hours' service. In the larger sets as many as five cells

Carrying cases in infinite variety have been designed for these sets, and many of them take their *motif* from the hand camera. The materials used in their construction may be wood covered with fabric, metal (usually aluminium), or plastic mouldings, including polystyrene. In most cases the automatic on-off switch is operated by the lid, but in one or two instances the converse is the case and the spring lid flies

open when the switch is operated.

Frame aerials are always wound inside the lid, and in spite of their small size have a higher Q than that of the ordinary portable in which the frame is wound round the outside of the chassis. Litz wire is used and the Q of the circuit is of the order of 140 at the low frequency end and 80 at the high frequency end of the medium-wave band.

Valve Substitution Notes

IN view of the probable shortage of DA30 valves in the near future, the Osram Valve Technical Department has advised that the PX25 valve should be used wherever possible for the maintenance of existing amplifier equipment.

When operating under Class AB1 conditions with fixed bias, the power available from a pair of PX25's is 20-25 watts, or only about 3 db. less than that from two DA30's under similar conditions.

The alterations required in the bias circuit connections is quite simple, and consists of reversing the fixed and variable portions of the potentiometer, so that a lower range of bias voltages may be made available.

With automatic bias circuits a value of 900 ohms per valve or 450 ohms for a common bias resistor is recommended. Bypass condensers may be electrolytics of 20 mfd., 50 volts working. The power output available with automatic bias is of the order of 15-20 watts.

Another possible alteration concerns the GU1 mercury vapour rectifier, which will shortly be replaced by the GU50. In the latter valve the anode connection is taken to the top cap instead of to pin 1 in the 4-pin base of the GU1. An external connection must therefore be provided from the underside of the existing valve when changing over to the GU50 valve.

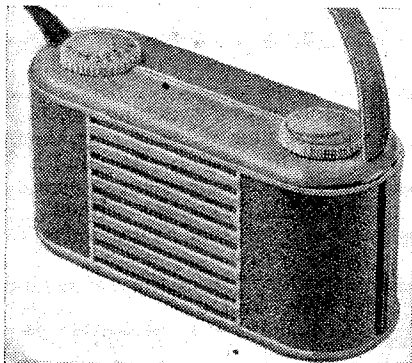

The Philco personal portable when closed resembles a miniature camera.

may be used in parallel. In the Motorola SA5, however, the five cells are connected to operate the filaments in series to avoid switching when changing from mains to battery. Normal plug connections are used for the HT battery, but sliding contacts are necessary for the LT on account of the comparatively high current, and the low resistance of the circuit.

The series resistance for mains operation is incorporated in the line cord as in the ordinary midget receiver.

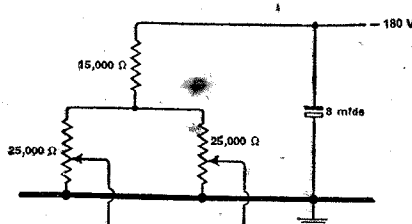

Modified circuit for supplying fixed bias to PX25 push-pull valves. In the circuit for DA30 valves the positions of the fixed and variable portions of the potentiometer are reversed.

Book Received

A Morse Memory Book. By Harold E. Palmer, D. Litt. The international morse code, with methods of memorising it. Although some of the aids to memory described operate through the sense of sight, and so are appropriate only to lamp or other visual systems of signalling, it is stressed that rhythmic methods given should be employed for any form of telegraphy where the sense of hearing is concerned. Pp. 32. Published by Memory Charts, Ltd., 3, Great Winchester Street, London, E.C.2. Price 9d.

LETTERS to the EDITOR

*The Editor Does Not Necessarily Endorse the
Opinions of His Correspondents*

Servicing in the Forces and Civil Life

WITH reference to your Editorial in the July issue, I am tempted to observe that any old television pole is quite suitable to beat the backs of the "Radio Service Engineers."

According to your article in the March issue, the Army requirements differ largely from the civilian and, as stated, the mechanical repair of apparatus is, perhaps, the greater part of the work to be done.

The technical standard required of manufacturers of Army and Air Force radio receiving and transmitting sets is very high; electrical faults are likely to be rare, while mechanical faults, due to accidents, are likely to be numerous.

This is exactly the reverse of civilian requirements; on the one hand the Army requires skill with hacksaw, file and drills, while the civilian radio receiving set requires for its repair a suitable cross between a clairvoyant and a wheel tapper.

Taplow, Bucks. G. A. RYALL.

I DO not share the optimism of Mr. Edward Rosen (reported in last month's Editorial) concerning the future of the technical side of commercial radio—or the future of the large number of men now being trained in the Services if they attempt to make their livings in radio after the war. First, judging by past experience, I am not convinced that the trade and industry will have much to offer them. Secondly, Service training is specialised for service equipment, theoretical tuition being merely preliminary and incidental. Good as the training may be for the right type of man, it does not greatly benefit anyone lacking a sound, general education, which most trainees do not possess.

I come in contact with many "radio men" who say—and I don't doubt it for a moment—that they have been "service engineers" for years. But they have only the most elementary and "popular" notion of radio, and have to be shown how to use the most ordinary measuring instruments and to be told what to measure.

It is not their fault. And here I

write as one who has been through the mill of commercial radio and does not intend to whitewash it. The business men of radio have neglected the welfare of their technicians and have not provided for the training of new men. The Services are now having to do, in a desperate hurry and with emergency methods and apparatus, something of what the trade and industry ought to have done for their technicians long ago.

I very much doubt whether the status of professional wireless men, or the technical service itself, or the general conditions of the industry, will be improved by the throwing on the labour market, after the war, of hurriedly trained men demobilised from the Forces in large numbers.

W. H. CAZALY.

Radio Ramps

MAY I bring to your notice two forms of wartime racketeering that are adding to the disrepute and suspicion with which the general public already regards radio service work?

First, since replacement valves became scarce certain dealers have been profiteering from the shortage. When a customer wants to buy a new valve they do not refuse to sell or say they have not got the valve; they simply tell the customer that if he cares to hand his receiver in they will "service" it for him. The "service" may consist merely of putting in either a new or second-hand valve and handing the receiver back—with a fat bill far exceeding the cost of the valve. This, of course, is merely a wartime variation of the sort of thing that has blackened radio service work in the past; at a time when radio reception is a vital national service it is inexcusable.

Secondly, although many dealers admit frankly that they can offer neither competent service work (owing to the calling up of their servicemen) nor any guarantee of being able to do any service work at all, they refuse to make available, even to perfectly competent and highly skilled radio men, technical information, such as circuit diagrams and test data, that would enable them to carry out repair work quickly and

easily on the sets of their relatives and friends. This dog-in-the-manger attitude is again a matter, nowadays, not merely of "business," but of serious concern to those who might have to rely on national broadcasts for news and announcements of extreme importance. Of course, a service diagram and notes are not absolutely necessary to a properly trained radio engineer, but they do help and might make all the difference when time is short, as it often is when a man is on leave. Is it too much to expect the trade and industry to help the national war effort by giving information generously?

RADIO MAN IN UNIFORM.

Shortage of Recording Blanks

AS the compiler of the Table of Direct Recording Blanks (see June, 1940, *Wireless World*) many enquiries for sources of supply are now being sent to me. May I say here that, unfortunately, no new supplies of blanks whatever are available? The "Simplat" and "Pyral" blanks, stocked by the V.G. Manufacturing Co., Ltd., are unlikely to be obtainable till after the war, and the entire output of the M.S.S. Recording Co., Ltd., is being allocated to B.B.C. and Government requirements, but an effort is being made to produce a certain quantity of discs for civilian users. When available an announcement will no doubt be made in your journal.

If any recordist has found a temporary solution of this disc problem, e.g., a method of removing the surface from old blanks and a formula and technique for re-coating successfully, perhaps he would care to pass on his knowledge to fellow enthusiasts?

DONALD W. ALDOUS.

Torquay, Devon.

BOOK RECEIVED

Handbook of Workshop Calculations. Issued jointly by the Board of Education, and the Ministry of Labour and National Service. This handy little volume is perhaps better described by the title of *Workshop Arithmetic*, since it provides a concise and practical course in that indispensable subject with particular application to the engineering industry. It contains forty pages of information leading up from elementary arithmetic to the more involved calculations to be found in workshop practice. Worked examples are given at each stage. It is in no sense a mathematical book and is intended chiefly for workers making their first contact with the engineering industry, whether as trainees under the Government's National Service scheme or otherwise. Price 3d.

Designing Small Portables

Use of High-inductance Tuning Circuits in Simple Headphone Sets

By S. W. AMOS, B.Sc. (Hons.)

THE outbreak of war gave a considerable impetus to the ultralightweight receiver, of the type intended for use with 'phones rather than with a loudspeaker. Some ideas which the author has found useful in designing such receivers will be discussed in this article, and, to illustrate the application of the main principle advocated, a set which can be constructed from the contents of the average "junk" box will be described in some detail.

The tuning systems of all receivers are based fundamentally on the simple parallel resonant circuit illustrated in Fig. 1. The impedance offered by such a circuit to a signal at its resonant frequency, known as the dynamic resistance, is given by the expression

$$\frac{L^2 \omega^2}{R} \text{ or } \frac{L}{CR}$$

Here L represents the inductance of the coil, C the capacity of the condenser, and R the effective resistance

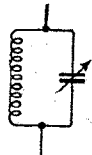

Fig. 1. Most tuning systems are based on this parallel resonant circuit.

of the circuit at the frequency in question. This includes the ohmic resistance, and the resistance due to skin and proximity effects. If, for a medium wave resonant circuit, L, C and R have the fairly conventional values of, respectively 157 μ H, 300 μ F and 3 ohms, then the dynamic resistance is given by

$$\frac{157 \times 10^{-6}}{300 \times 10^{-12} \times 3} = 175,000 \text{ ohms.}$$

This quantity is a measure of the amplification given by the tuned circuit, and it is at once clear that amplification can be increased by reducing C and increasing L. The product of L and C must, however, remain the same, for the waverange covered by the circuit depends on this product, as shown by the formula $\lambda = 1885 \sqrt{LC}$. If, therefore, L is increased five times to 785 μ H and C decreased to the nearest practical maximum value of 100 μ F, then the waverange will be unaffected but the dynamic resistance will be increased. How great the in-

crease will be we cannot say, for R, the effective resistance, will naturally be greater for a coil of 785 μ H inductance than for one of 157 μ H.

Fortunately, however, we can easily eliminate the effects of an increase in R by the use of reaction. A reacting valve behaves as a negative resistance, and as such is capable of neutralising a positive resistance in circuits to which it is connected. Accordingly, if in this high-inductance circuit we reduce R to the same magnitude as in the more conventional circuit, then we should obtain 25 times as much amplification from it as from the other. This represents an improvement in gain of $20 \log 25 = 28$ decibels.

Waverange Restriction

As might be expected, there is a snag in this method of obtaining amplification, and it is connected with the waverange of the circuit. The standard value for the maximum capacity of a tuning condenser, 500 μ F, was originally chosen by designers because, in conjunction with a coil of 157 μ H inductance, it enabled the broadcast waverange of 200-550 metres to be covered easily even when

considering, the waverange covered will be less than 200-550 metres, unless the stray capacities can be reduced to a very low amount.

The chief sources of stray capacity are due to the aerial coupling and the minimum capacity of the tuning condenser. By use of a good short-wave component the latter can be reduced to about 7 μ F. Extra capacities due to the valve (if a triode), the self-capacity of the coil, and the wiring amount to some 10 μ F. There still remains the capacity due to the aerial coupling. To realise the extra 28 decibels the aerial coupling must clearly be as good as that employed in conventional tuned circuits, and this means the addition of considerable capacity, possibly as much as 50 μ F, which will reduce the ratio of maximum to minimum wavelength receivable from the normal value of 2.75 to 1.5.

Such a restricted waverange seems at first sight undesirable, but when one reflects that it still permits reception of the Forces programme on 342 metres, and the Home Service on 449 metres, and with extra gain of 25 times, our objections are not so great. Moreover, the author has found that, by using a very loose aerial coupling the waverange 200-550 metres can be covered even with this high-inductance

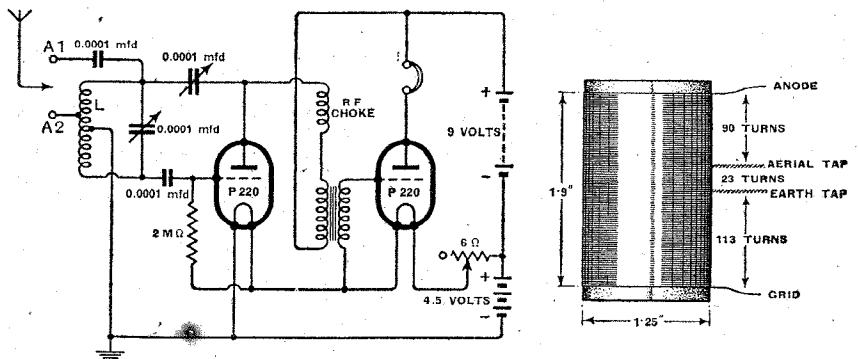

Fig. 2. Complete circuit diagram of the lightweight receiver discussed in the text. Inset is shown winding details of the tuning coil (inductance approximately 800 μ H). The wire is No. 36 SWG, enamel covered.

all the stray capacities which are inevitably present in any practical tuning circuit are in parallel with it. With a tuning condenser of maximum capacity 100 μ F such as we are now con-

sidering, the coupling was obtained by tapping the coil so that about 1-10th of the total number of turns on the coil were included in the aerial circuit. This means that only 1/10th of the

Wireless World

aerial capacity is "reflected" into the tuned circuit, and, as average aeri-als have a capacity generally less than 300 $\mu\mu\text{F}$, then the reflected aerial capacity cannot exceed 3 $\mu\mu\text{F}$. This is, however, a very inefficient coupling, and the extra gain of the circuit is largely offset by the losses introduced. Nevertheless, it does permit reception of the entire medium waveband.

Possibly the most convenient reacting circuit for a small portable receiver to operate headphones is that shown in Fig. 2, for this gives good control of reaction at all settings of the tuning control with an HT supply of only 9 volts, which can be obtained from a GB battery. The circuit is open to the objection that both sides of both variable condensers are at high potential with respect to earth, and consequently, to avoid hand-capacity effects, control of reaction and tuning must be carried out by means of earthed shafts connected to the condensers by insulated couplings.

Details of the construction of the tuning coil L, which has an inductance of 800 μH are inset in Fig. 2. With a good outdoor aerial attached at the terminal A1, a waverange of approximately 320-570 metres is obtained, and the Home and Forces programmes could be well received. Using a more conventional two-valve receiver, it was found that the HT voltage had to be increased before satisfactory reaction effects could be obtained, and that, even when this had been done, reception of these two programmes was in no way superior to that given by this receiver. Unfortunately, no means was available of checking whether the calculated improvement in gain of 28 decibels was realised in practice, though there is no doubt that the high-inductance resonant circuit is more sensitive than the more conventional arrangement. It is obvious that the actual waverange receivable with terminal A1 in use depends upon the constants of the aerial-earth system. If the aerial be connected to terminal A2 then the waverange covered is 200-550 metres, though signal strength is much poorer, for the few turns included in the aerial circuit give a resonant frequency much higher than any in the medium waveband. Reception can be improved by connecting a loading coil of about 157 μH in series with the aerial, for this will generally give a resonant frequency situated in the medium waveband. Unfortunately, it may also cause irregularities in the control of reaction. The receiver readings, with the aerial connected to this terminal, are practically independent of the aerial constants.

The AF section of this receiver is perfectly straightforward. The inter-valve transformer is a midget component designed for parallel feed connection, but it works quite satisfactorily when carrying the very small anode current of the detector valve. Small 2-volt battery-driven power valves of the P220 type are used for detection and AF amplification, their 0.2-amp filaments being connected in series and supplied with current via a 6-ohm rheostat from a 4.5-volt dry battery. The new 1.4-volt valves could be used here with their filaments in parallel and energised from a single dry cell.

Book Review

Elementary Mathematics for Wireless Operators. By W. E. Crook, A.M.I.E.E., A.F.R.Ae.S. Pp. 63. 42 diagrams. Sir Isaac Pitman and Sons, Ltd., Parker Street, Kingsway, London, W.C.2. Price 3s. 6d.

THIS is a book of the "Mathematics without Tears" type, designed to help wireless operators with limited mathematical knowledge to solve readily the problems they encounter. It is admittedly a difficult task to write such a book, for the background of knowledge possessed by the reader is largely an unknown quantity.

Chapter I deals with brackets, powers and logarithms, and much space is very properly devoted to evaluations by logarithms of the type of expressions obtained by substituting figures for symbols in well-known formulae.

It is a little surprising to find, in Chapter II, work on the fundamentals of algebra, beginning with symbolism and leading up to rearrangement of algebraic expressions. Parts of this might have been better placed in Chapter I, where so much use is made of formulae, though it is possible that any such change might introduce further anomalies.

Geometry and trigonometry are introduced in the next chapter, which is followed by Chapter IV on graphs. It is a pity that these two chapters do not contain any numerical examples, which would have made the practical applications of the work immediately obvious to the reader. The final chapter deals with mechanics, simple harmonic motion and the decibel.

The author deserves congratulations on compressing so much material inside 63 pages. There is much useful material in the book and radio operators should benefit from a study of the very many numerical examples which are given in the earlier chapters.

S. W. A.

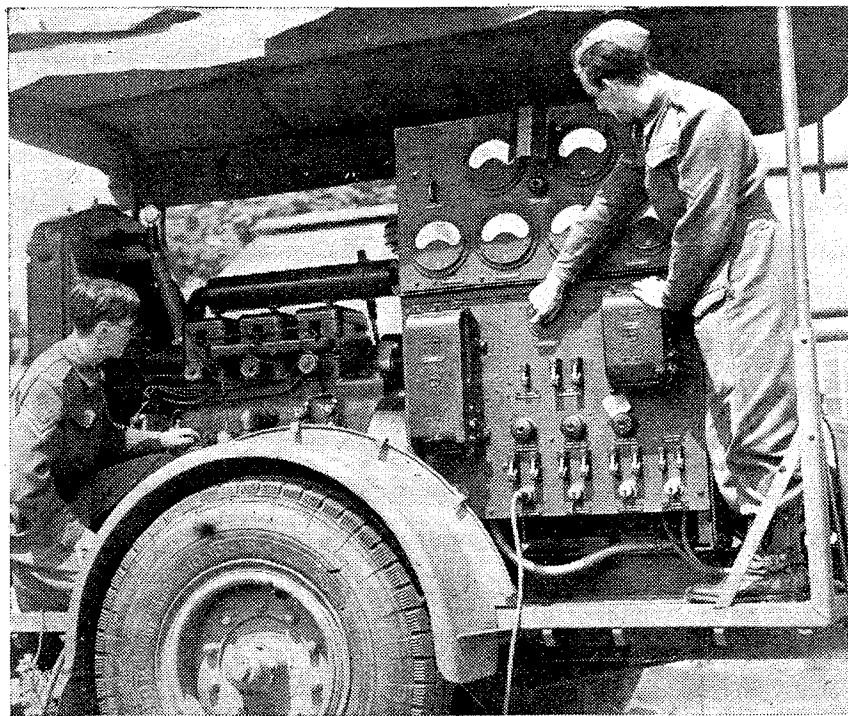

Wireless technique in the defence of Britain: the Power Generator of a mobile radiolocator.

More Makeshifts — Receiver

By W. H. CAZALY

WHEN replacing the frequency-changing valve in a superheterodyne receiver by one of another type, three factors have to be considered. First, there is the matter of rewiring. Secondly, there are the tracking constants of the oscillator coil group. Thirdly, there is the matter of how the coil group will work with the new valve in producing the required oscillations at the correct intensity.

There is often a fourth factor—the suitability of the valve for use over the frequency range desired. This counts especially on the short-wave bands.

Rewiring is a matter of common sense. Figs. 1 and 2 show how various coil groups can be reconnected to dif-

ferent types of frequency-changer, and the main thing is to arrange the wiring so that the incidental reactances provided by the various leads to the valve electrodes suffer as little change as possible from those present in the original wiring. This means that the wires should take as far as possible the same physical positions as they did with the old valve, and that any lengthening of leads should be carefully considered and arranged so that the extra length of wire is kept well away from earthed parts and from other wiring. In brief, the alterations must be carried out neatly. The oscillator section is one of the touchiest in the circuit, and clumsiness and untidiness in alteration may completely upset its operation.

The tracking of the oscillator group with the signal frequency circuits, as tuning is carried out by the gang condenser over the band covered, is taken care of by the designers of the set. It depends simply on the inductances and capacities involved, and if these are not altered greatly by the rewiring operation, matters can usually be brought back to normal by adjustment of trimmers and padders. A test oscillator is, of course, a great help in such readjustments, but not essential. If a test oscillator is not available it is possible to play about with the trimmers until the best apparent results are obtained, *provided the IF tuning is not upset*. If, therefore, the receiver was working well before the breakdown of the frequency-changer valve, the IF trimmers should on no account be

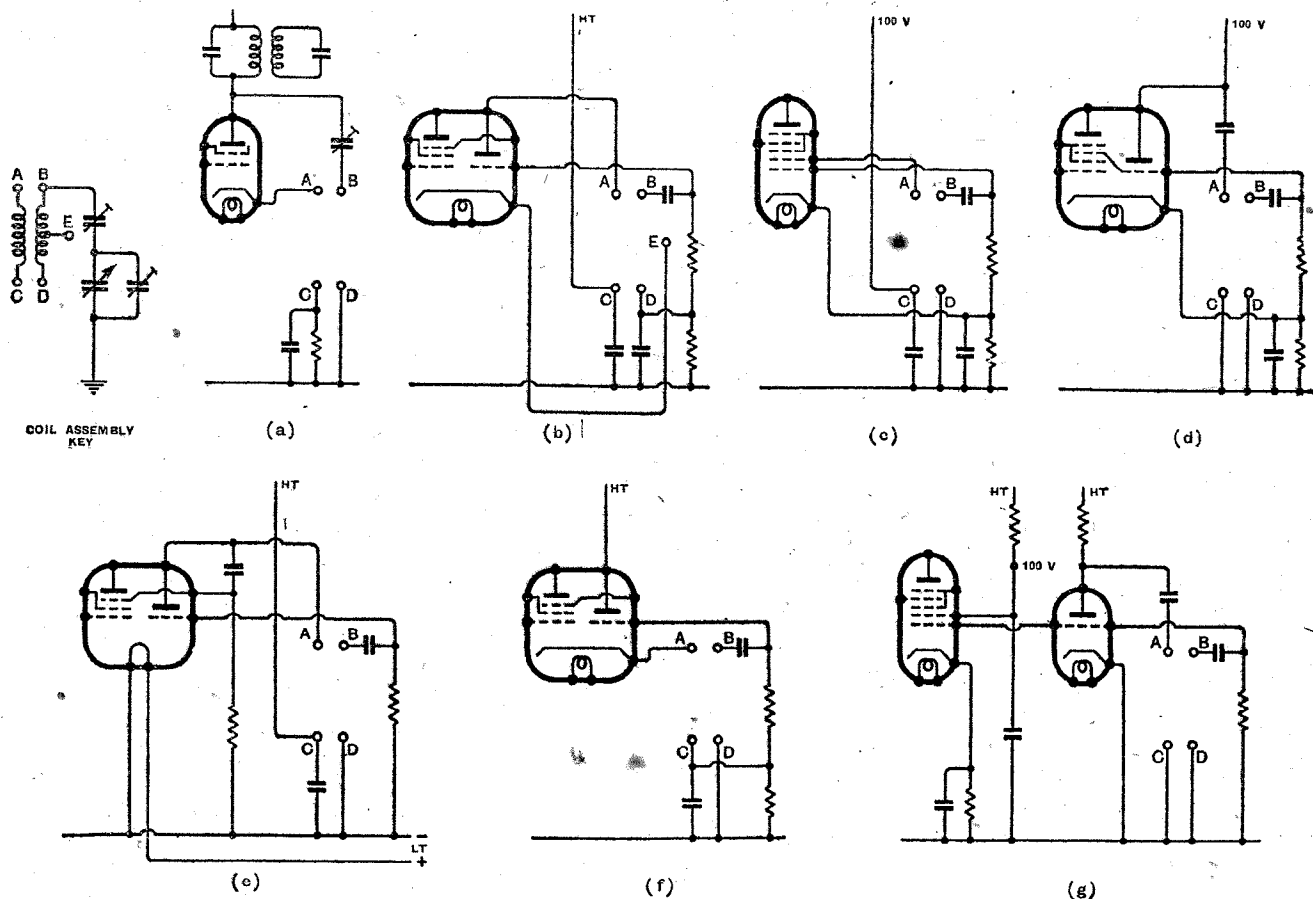

Fig. 1. Circuits employing the two-coil oscillator group. (a) autodyne; (b) triode-pentode; (c) heptode; (d) triode-hexode; (e) battery triode-pentode (note condenser coupling to pentode suppressor grid); (f) another mains-fed triode-pentode arrangement; (g) heptode with separate oscillator. Battery-fed single-valve mixers use similar coils, but battery autodyne and triode-pentode frequency-changers usually employ a third low-resistance dual winding carrying the filament current, as in Fig. 2.

Maintenance in the Face of Shortages

Improvisations and makeshifts that would hardly be tolerated in peacetime are now necessary for the maintenance of broadcast receivers. In the June issue many general suggestions were given; the present article deals with makeshift replacements of the frequency-changer and power rectifier

touched; even without manufacturers' service notes it is easy enough to trace out the pre-set condensers of the oscillator coil group and to distinguish between the padders and the trimmers—the former in series and the latter in parallel with the oscillator tuned circuit elements. As a general guide it may be assumed that maladjustment of the padder will lead to poor tracking at the lower frequency (longest wavelength) end of the band, and of the trimmer at the higher frequency end. If the inductances are permeability trimmed by adjustable iron-dust cores, they will affect the tuning most at the lower frequency end, while the trimming condensers will have most effect at the other end.

Oscillator Operation

The third factor, involving the behaviour of the oscillator coil group and the new valve as a generator of alternating potentials, is dependent partially on the properties of the valve itself. A change of valves may therefore lead to changes in the intensity of the heterodyning voltage developed, especially at different parts of the frequency band. An ideal oscillator would develop this voltage at a constant intensity—the "optimum heterodyne"—such that it caused the valve to work always on a certain part of its characteristic curve, rather in the same way (to put it very roughly) this bias is applied to an amplifying valve to make it work, or handle signals, about a point approximately midway along the straight part of the I_a/V_g characteristic. It is easy enough to arrange for this at any one frequency, but when a wide frequency band has to be covered by a single tuning condenser, so that considerable changes in L/C ratio occur, the intensity of the oscillations is liable to change. For this reason, oscillators are nearly always steadied by the use of the common grid leak and condenser coupling to the grid coil, so that as the intensity of oscillation tends to increase it is offset by the appearance of an increased negative potential at the grid end of the leak. In this way a fairly constant intensity of oscillation is obtained over a whole band of frequencies.

This can be done with any valve oscillator on its own. But in the case of the single-valve frequency-changer, the negative potentials so developed

at the grid of the oscillator section of the valve may affect the behaviour of the signal-handling section. Cases may arise, therefore, when the change-over from one type of frequency-changer to another without any alteration in the oscillator coil group may cause poor performance of the signal-handling section of the new valve. If this is noticeable, or if it occurs over portions of the band covered, it is worth while trying to remedy matters by controlling either the intensity of oscillation or the amount of negative potential developed at the oscillator grid.

Since it is not possible to alter the coupling between the anode and grid coils of the group, all that can be done to alter the intensity of oscillation is deliberately to introduce losses, as, for example, by connecting a resistance of the order of anything from 50,000 to 100,000 ohms across either the grid or the anode coil (whichever is tuned). This will only be of value, of course, if the oscillations are too strong originally; if they are too weak already for the new state of affairs, adding the resistance to the circuit will do no

value of the leak, since it is effectively acting as a load on the oscillating circuit, will also tend to reduce the intensity of oscillation. Increasing it in value will lessen the damping on the oscillator circuit, but will increase the negative potential at the grid. Although it is hardly possible, under such circumstances as are being borne in mind, to calculate and predict any desirable change in the value of the oscillator grid leak, it is worth while experimenting with it if the performance of the set seems to be appreciably affected by the change in frequency-changers, in spite of every care having been taken over rewiring.

FC Valve Peculiarities

The peculiarities of frequency-changing valves manifest themselves largely in the form of differences in performance according to the frequency handled. The following hints, as a rough indication of what to expect,

Fig. 2. Diagram (a) shows a coil assembly often used for battery triode-pentode oscillators; (b) is a 3-winding arrangement for battery heptodes.

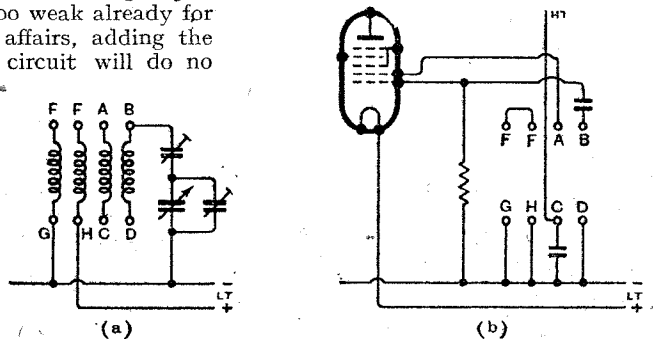

good. This can only be ascertained, in the absence of proper instruments, by experiment. The negative potential developed at the grid of the oscillator section depends partially on the intensity of oscillation and partly on the value of the grid leak. Reducing it in value will have the effect of reducing the negative potential developed for any given intensity of oscillation; but this reduction of the

may be of service if the experimenter is lucky enough to have a choice of replacement valves: (a) The "autodyne" (Fig. 1) is now little used because it is not so easy to maintain oscillation at the higher frequencies, and because a good deal of the oscillator output is conveyed to the signal circuits through valve capacities. It works best at broadcast frequencies. (b) The triode-pentode, which is really

More Makeshifts—

a two-valve type of frequency-changer, is excellent on broadcast frequencies, but on higher frequencies an undesirable amount of oscillator output appears, as with the autodyne, in the signal circuits, unless (if two separate

a series resistance—allowing, for the considerable decrease in current taken by the filament of such a valve, a little over for the increased voltage developed across the rectifier winding owing to the lessened load on it.

Certain factors, however, must be

increase instead of being directly proportional. The same reasoning applies to the primary winding. It is, therefore, inadvisable to effect this sort of conversion in the HT supply section of a receiver unless the mains transformer is of substantial size and

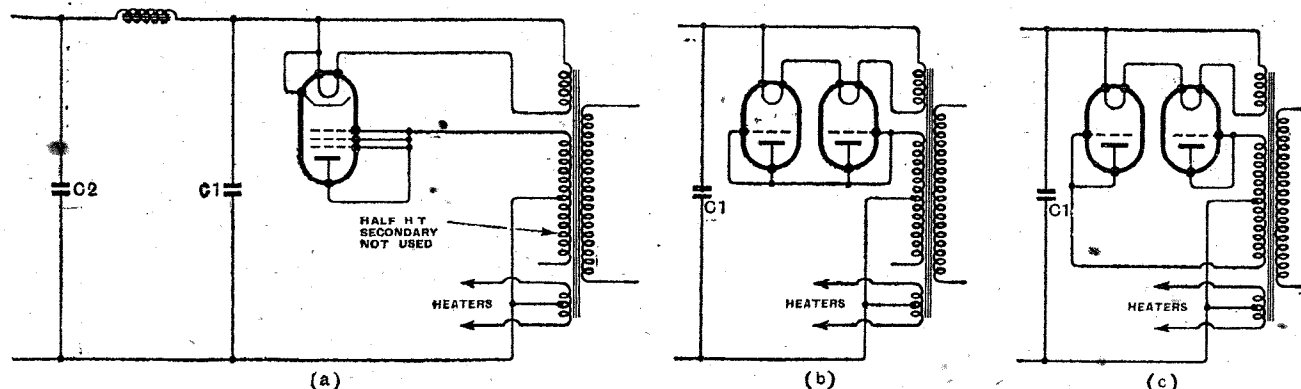

Fig. 3. Pressing odd valves into service as power rectifiers. C1 is the reservoir and C2 the smoothing condenser.

valves are used) rather elaborate devices are employed to isolate them. (c) The heptode is also excellent on broadcast bands, but on the short-wave bands the sensitivity falls seriously below 25 metres or 12 Mc/s, and AVC voltages on the grid cause frequency drift that is troublesome at high frequencies. (d) The triode-heptode and triode-heptode are both good at broadcast and higher frequencies, and, on the whole, are to be preferred for modern receivers if they can be obtained. From the above notes, some idea of what to expect from a change of frequency-changer valve can be secured. Admittedly, it is usually a case of Hobson's choice in these days!

The Power Rectifier

Another troublesome replacement is that of the rectifier in an AC mains receiver. It is often possible, however, to press an old pentode or power triode into service by joining the anode and all the grids, and thus converting it into a diode, as shown in Fig. 3 (a). Even battery triodes of the "power" type—and some of the older ones that may be found in the junk box used to pass what would nowadays be considered inordinately high anode current for battery drive—can be employed, if possible in parallel, as shown in Fig. 3 (b) and (c). Their lives may not be long, but if they serve their purpose during an emergency they will have died honourably. If only one such 2-volt battery valve is available, the filament current from the 4-volt rectifier winding on the mains transformer must be limited by

borne in mind when making such alterations to the HT supply system. First, unless the arrangement shown in Fig. 3 (c) is used, with either mains or battery valves, rectification will become half-wave instead of full-wave, and the output will in consequence contain a higher percentage of ripple than before, and if this gives rise to objectionable hum the smoothing must be increased. This can be done either by increasing the smoothing capacity (C2 in Fig. 3 (a))—say, by doubling it—or inserting an extra choke of low DC resistance (say, 500 ohms maximum, and about 8-10 henrys inductance) in series with the existing smoothing choke, which may itself be the field winding of the speaker.

Secondly, without further alteration than replacing the rectifier valve by an emergency valve used as a single diode, the output of the unit will fall seriously. This will be because the power supplied through the rectifier to the reservoir condenser will be available only during one half-cycle—that making the anode of the rectifier positive—instead of during both half-cycles as previously. To make up for this the current passed by the rectifier during the working half-cycle will have to be doubled in order to maintain the charge in the reservoir condenser. Ripple will be increased from this cause, too. And the excessive surge current at each positive cycle will considerably shorten the life of the valve used as a rectifier. It is also possible that the HT secondary winding may be of such fine gauge that the peak current, double the original, may overheat it, owing to the heat generated being proportional to the square of the

can stand a fairly big overload. The output voltage available to feed the valve anode circuits can be raised, if it falls too much for tolerable performance of the receiver, by increasing the capacity of the reservoir condenser—at the expense of the life of the valve unless it is a fairly powerful mains triode capable of passing, say, 100 mA without damage. The inclusion of fuses in the mains input leads is distinctly a safe move, just in case ill-judged arrangements cause danger.

Indispensable for Radio Research.

A PAPER on the relative importance of the various scientific periodicals of the world was released by the U.S.A. Navy Department for publication in the *Review of Scientific Instruments* a few years ago. In this the writer mentioned "the valuable abstracts in *The Wireless Engineer*, which alone would make that journal indispensable for radio research."

Our sister journal still maintains this service at the same high level, even in the present difficult circumstances.

In addition to the twenty-three pages occupied by the Abstracts and References section the July issue contains the regular monthly summary of recently accepted wireless patent specifications, and articles on measuring the AC impedance of chokes and transformers, half-wave modulation and the inductance linearised time base. Recently expressed views on the velocity of acoustical and electromagnetic waves are discussed editorially.

The Wireless Engineer, which is published on the first of the month, is obtainable to order through newsagents or direct from our publishers at Dorset House, Stamford Street, London, S.E.1, at 2s. 8d., including postage.

THE WORLD OF WIRELESS

FOREIGN QSL CARDS

Restrictions on Amateurs

IT has been found necessary in the interests of national security to prevent certain information concerning the reception of broadcasts and wireless signals from leaving this country. The public, and in particular radio amateurs and short-wave listeners, are therefore asked not to send to addresses outside Great Britain:

(1) Any correspondence containing references to the reception of wireless signals or speech (other than correspondence addressed to recognised broadcasting stations in friendly countries referring to reception of their broadcasts).

(2) Any QSL or SWL cards (whether the spaces are filled in or left blank) or any letters or cards of a similar kind, or

(3) Any reports prepared by radio correspondents or reporting clubs or societies or the like, containing lists of stations received by their members.

Any correspondence of the kind described above is liable to be stopped by the Censorship Authorities.

It is to be noted that radio trade correspondence, letters between amateurs about set construction or other

technical problems, or any other correspondence on radio topics which does not fall within the above description is not affected. At the same time the authorities realise and regret that the application of these rules will interfere with what is in the case of most correspondents a harmless and fascinating hobby, but unfortunately it is possible for information which would be of use to the enemy to be sent out of the country by these means, and this must be prevented. It is suggested, however, that wireless amateurs who wish to keep in contact with overseas friends might adopt a suitable form of wartime radio greeting card, which would state the name and address of the sender, and would not contain any code groups or reports of reception.

When all other correspondence must be written in plain language it seems unreasonable that amateurs should have the privilege of writing in something closely resembling a code, which must greatly increase the work of the censors. The new restrictions set forth above will therefore be accepted readily.

U.S. TELEVISION

FM Sound : AM Vision

THE U.S. Federal Communications Commission recently announced that having found the wireless industry "entirely in agreement that television broadcasting is ready for standardisation," it authorised full commercial operation from July 1st. The standards fixed by the F.C.C. are 525 lines, 30 frames interlaced, with frequency-modulated sound transmission and amplitude-modulated visual signals.

Eighteen frequency channels, each 6 Mc/s wide, have been assigned for the use of television transmitters. They are:—

Mc/s	Mc/s
59—56	186—192
60—66	204—210
66—72	210—216
78—84	230—236
84—90	236—242
96—102	258—264
102—108	264—270
162—168	282—288
180—186	288—294

One channel only will be assigned to each station, which must transmit for a minimum of 15 hours a week.

It is fifteen months since the F.C.C. rescinded its previous order permitting part-time commercial operation of television transmitters. During this stalemate the interest in television has waned considerably. The attitude of the manufacturers towards the latest announcement is, as might be expected, quite the reverse to that of just

TECHNICIANS FOR RADIOLOCATION

Opportunity for American Wireless Men

THE recently organised Civilian Technical Corps, which offers American men an opportunity for service in England, is a "non-military body of paid volunteer craftsmen in certain skilled trades which has been established by the British Government to maintain and repair the highly technical equipment used by the naval, military and air forces of the British and their Allies." Volunteers accepted for the Corps become paid, non-combatant employees of the Government.

In calling for volunteers, Air Commodore Pirie, air attaché to the British Embassy in the U.S.A., stressed the fact that while technicians in all kinds of trades are needed, the most pressing demand is for both professional and amateur radio technicians for the operation of radio-locators.

Volunteers for duties as radio mechanics, who must agree to serve for three years, or for the duration of the war, whichever is the shorter, must be between 18 and 50 years of age. They will receive free board and

accommodation, distinctive clothing with a special insignia and will be paid from £6 to £9 per week, according to grading.

A radio mechanic, whose duties will include the overhauling, maintenance and inspection of complex UHF wireless apparatus, must have a sound working knowledge of radio, both practical and theoretical, and be adept in the use of tools.

The power switchboard of a radio-location station.

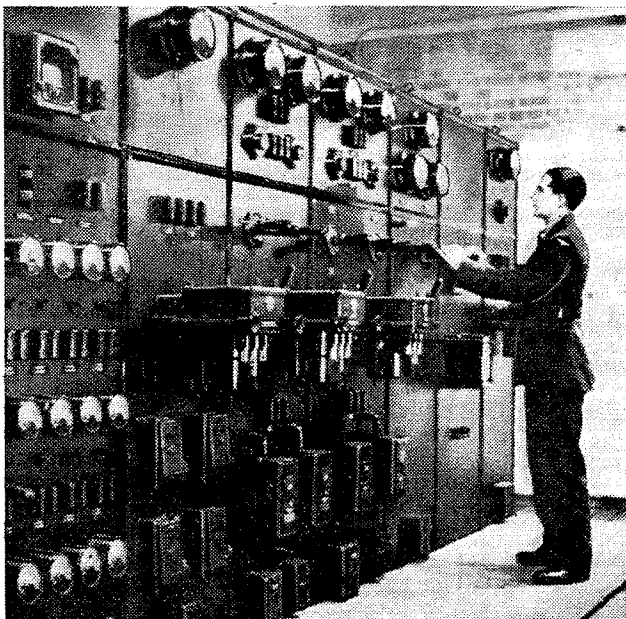

The World of Wireless—

over a year ago and is aptly expressed by Mr. Sarnoff, president of the R.C.A., who said "the increasing demands upon our facilities and technical experts made by the requirements of national defence, and the matter of priorities, may affect the establishment of the new service."

METAL RECTIFIERS

I.E.E. Paper and Discussion

AN interesting and informative exchange of views on metal rectifiers took place at a recent meeting of the I.E.E.—the first ordinary meeting to be held at the Institution's London headquarters during the evening for over a year. The discussion followed the reading of two papers. The first paper, dealing with copper-oxide rectifiers, was read by Dr. A. L. Williams and Mr. L. E. Thompson, of the Westinghouse Company, and the second paper, dealing with selenium rectifiers, was read by Mr. E. A. Richards, of Standard Telephones and Cables.

It was made clear that the name metal rectifier is not fully appropriate to either type, since they are not fully metallic. Actually they are devices in which rectification takes place at the contact between two dissimilar substances, one of which is a metal. The action appears to be purely electronic, there being no apparent signs of any chemical change taking place. The exact *modus operandi* is still somewhat doubtful, however. In the case of the copper-oxide type none of the theories so far advanced is fully satisfying.

The copper-oxide type has been in use for some fourteen years, whereas the selenium type has only become prominent in recent times. The G.P.O. and also the B.B.C. use them extensively. One of their principal uses is in apparatus for starting aero engines.

B.B.C. AND AMATEUR BAND

AS a result of correspondence between the Radio Society of Great Britain and the G.P.O., the latter has given an assurance that the B.B.C.'s use of frequencies at the lower end of the 7-7.2-Mc/s amateur band is entirely a wartime measure and that the P.M.G. will "bear in mind the desirability of restoring the band to the exclusive use of amateurs after the war."

The R.S.G.B. understands that the American Radio Relay League is attempting to persuade the B.B.C. to reduce the strength of the signal in the direction of N. America of the transmission in the 7-Mc/s band intended for the Eastern Hemisphere.

NETWORK BROADCASTING

Radical Changes in U.S. Proposed

NEW regulations recently proposed by the Federal Communications Commission will, if adopted by Congress, radically change the entire structure of broadcasting in the United States. "What is to-day the best and freest radio system in the world will," says *Broadcasting*, "begin rotting away—the prelude to a Government-operated system."

Space will not permit a detailed survey of the report, which is the result of a three-year investigation by the F.C.C. and occupies over 150 pages. Suffice it to say that this "network monopoly report," as it is called, will severely shake, if not break up, the very foundation of American broadcasting, i.e., the great nationwide networks of stations.

B.B.C. WAVELENGTH ALTERATIONS

ONE of the aims of a number of wavelength changes in the B.B.C. European Service made on July 6th is to provide increased signal strength over France. GSE (25.29 m.) is now using an aerial directional over France, which, it is anticipated, will give an improved signal over the southern part of the country. An aerial directional on the whole of North and Central France is now being employed by GRT (41.96 m.).

The wavelengths which are at present in use in the European and World Services for the transmission of news in English and the times (BST—2 hours ahead of GMT) at which they are radiated, are:—

06.00 ...	49.59,*	41.49,*	30.96.*			
06.45	}	31.32,	31.25,	25.53.		
02.00						
02.45						
06.30						
08.15 ...	42.46,	31.55,	31.25,	25.53,	19.82,	19.66.
10.00 ...	49.59,*	41.49,*	42.46,	31.55,	25.53,	25.29.*
			19.82,	19.66,	19.60.	
13.00 ...	31.25,	25.53,	19.82,	16.84,	16.64,	13.97.
15.00 ...	19.82,	16.84,	16.64,	13.97,	13.93.	
15.30 ...	49.59,*	41.49,*	25.38,*	25.29,*		
18.00 ...	31.75,	25.53,	19.82,	16.84,	13.93,	13.92.
20.00 ...	31.25,	25.53,	24.92,	19.82,	19.60,	16.84.
22.45 ...	31.25,	25.53,	19.82,	19.60.		

Wavelengths marked with an asterisk are used in the European Service.

WRCA—WNBI

ACCORDING to *Broadcasting*, the N.B.C., at the instigation of the U.S. State Department, is making preparations to operate its short-wave transmitters for 24 hours a day. Recent experiments, in which the two 50-kW transmitters, WRCA and WNBI, operated simultaneously on the same wavelength, resulted in a signal equal to that from a 100-kW station. It has therefore been decided to use the dual output for at least a part of the N.B.C.'s new international schedule.

AN HISTORIC ANNIVERSARY

A Pioneer Radio Concert

THAT broadcasting is a good deal older than the B.B.C. is called to mind by the fact that it is just over twenty-one years ago since the first "all-star" concert was radiated from a wireless transmitter in this country. It was on June 15th, 1920, that Dame Nellie Melba broadcast from the Marconi Company's station at Chelmsford, the sound of her voice being picked up not only at widely separated places in Europe, but also by ships at sea, most of which had only crystal receivers; some not even having reached that stage were carrying on with the old magnetic detector.

The wavelength used was distinctly long by modern standards, 2,800 metres. The power was fifteen kilowatts, this being not the power in the aerial but the rating of the generator. The concert was arranged by Mr. Arthur Burrows, of B.B.C. fame, and Mr. T. Clarke, of the *Daily Mail*. A full account of this pioneer experiment was published in *The Wireless World* of July 10th, 1920.

FROM ALL QUARTERS

"A Technical Hitch?"

AN instance of the disorganisation which might be caused by an enemy saboteur was given the other day at Kettering when no fewer than 250 people were cut off from the reception of broadcasting by the act of a man who, in the course of certain "experiments" interfered with wires belonging to the local radio relay service. He was fined £5.

Ship's Emergency Receiver

AN emergency crystal receiver is part of the radio equipment to be installed by the Radiomarine Corporation of America on nearly 100 U.S. vessels now under construction.

London Transformer Products

WE have been asked to announce that Mr. T. S. Worthington, who was an active director of London Transformer Products, Ltd., for seven years, recently rejoined the Navy as sub-lieut. R.N.V.R. for technical duties.

Identifying U.S. Aircraft

AMERICAN aircraft have now been added to the series of identification charts published by our associate journal, *Flight*. Printed on a card measuring 22½ in. by 14½ in., the chart includes twenty-one different types of aircraft in use by the R.A.F. and Fleet Air Arm. The chart, which costs 1s. 3d., plus postage, which is sixpence for one copy or sevenpence for two copies, may be obtained from *Flight*, Dorset House, Stamford Street, London, S.E.1.

Wireless World

N.B.C. Colour Television

THE N.B.C. gave its first colour television demonstration in New York a few weeks ago. The system employed is similar to that demonstrated by C.B.S., in which the colour scanning is mechanical and is of 120 lines, giving 20 interlaced frames a second.

Cinema Television in New York

A SCOPHONY rear-projection mechanical television receiver with a roof, by 12ft. screen is being installed in the Rialto Theatre, New York, which will then be the first American cinema to offer television as well as motion pictures. It is understood the apparatus is similar to that installed in the Monseigneur news theatre, Marble Arch, London, in March, 1939.

Brit. I.R.E.

At the annual general meeting of the British Institution of Radio Engineers, held on June 28th, Dr. C. C. Garrard, Ph.D., M.I.E.E., M.Brit.I.R.E., was elected president of the Institution. The following were elected by postal ballot as the 1941-2 General Council: Mr. A. L. Beedle, Dr. P. P. Dalton, Messrs. A. G. Egginton, L. Grinstead, G. Lea, W. E. Miller, J. F. Paull, J. A. Sargrove, W. D. Sell, and H. Tibbenham.

I.E.E. President

SIR NOEL ASHBRIDGE, M.I.E.E., controller of the engineering division of the B.B.C., has been elected president of the Institution of Electrical Engineers.

Marconi Memorial in Washington

A MEMORIAL to Marconi is to be erected in Washington, U.S.A. It takes the form of two granite pedestals, the smaller one in the front, which is 7 feet high, being surmounted by a bust of Marconi 3 ft. 8in. high. This pedestal and bust are backed by a wider and taller pedestal which is surmounted by a bronze figure symbolizing electricity.

Netherlands Broadcasting

SINCE the occupation of Holland by Germany the various broadcasting systems, which were under the auspices of a number of different organisations, have been dissolved and replaced by a State organisation. A licensing system has been introduced, the fee being 9 Gulden (approx. 18s. at par.) per annum.

An Appeal

IN an endeavour to raise £50,000 to provide help for the people of the ten worst bombed towns in Great Britain, George Formby, the variety artist, is appealing to all wireless service men and listeners to send him, c/o the B.B.C., London, one shilling.

I.E.E. Wireless Section

No nominations having been received other than those proposed by the Wireless Section committee, which were given in last month's issue, they have been duly elected to fill the vacancies occurring on the committee on September 30th.

The Wireless Industry

DETAILS of a new compact PA amplifier are given in Leaflet No. 28 recently issued by the General Electric Co., Ltd., Magnet House, Kingsway, London, W.C.2. Known as the "Microgram," this unit is equipped with a gramophone turntable and a transverse-current hand microphone. Independent volume controls are provided, and the two inputs can be mixed if desired. The power output is 14 watts undistorted.

Barimar, Ltd., are now in a position to undertake welding repairs at their new address, Kent House, 22-24, Peterborough Road, Fulham, London, S.W.6.

Standard Telephones and Cables, Ltd., inform us that the Types HS and HSL transmitters can now be fitted with additional units for matching to 600-ohm balanced twin open wire transmission lines.

NEWS IN ENGLISH FROM ABROAD

REGULAR SHORT-WAVE TRANSMISSIONS

Country : Station	Mc/s	Metres	Daily Bulletins (BST)	Country : Station	Mc/s	Metres	Daily Bulletins (BST)
America				Manchukuo			
WNBI (Bound Brook)	17.780	16.87	4.0‡, 6.0.	MTCY (Hsinking) ..	11.775	25.48	9.0 a.m., 11.5.
WCAB (Philadelphia)	6.060	49.50	12.45 a.m.†, 1.30 a.m.†.	Sweden			
WCBX (Wayne) ..	17.830	16.83	2.0‡, 3.0‡.	SBO (Motala) ..	6.065	49.46	11.20.
WGEO (Schenectady)	9.530	31.48	8.30‡, 10.55‡.	Thailand			
WGEA (Schenectady)	15.330	19.57	1.0, 2.0‡, 6.0, 7.45.	HSP5 (Bangkok) ..	11.715	25.61	1.45.
WRUL (Boston) ..	6.040	49.67	12.15 a.m.‡.	HS6PJ	19.020	15.77	1.45.
WRUL.. ..	11.730	25.58	12.15 a.m.‡.	Turkey			
WRUL.. ..	11.790	25.45	9.30‡.	TAP (Ankara).. ..	9.465	31.70	8.15.
WRUL.. ..	15.350	19.54	5.0*, 6.0‡, 9.30‡.	TAQ	15.195	19.74	1.15.
WRUL.. ..	17.750	16.90	5.0*, 6.0‡.	U.S.S.R. (Moscow)			
Australia				49-metre band.. ..	—	—	11.0, 12.0 midt.
VLR3 (Melbourne) ..	11.850	25.32	6.20.	41 " " " ..	—	—	7.15, 11.0, 12.0 midt.
Egypt				31 " " " ..	—	—	10.5 a.m., 7.15, 9.30,
SUX (Cairo)	7.860	38.14	7.50, 11.10.	25 " " " ..	—	—	11.0, 12.0 midt.
Finland				19 " " " ..	—	—	2.30, 7.15, 9.30, 11.0, 12.0 midt.
OFP (Helsinki) ..	8.585	34.94	9.20.	16 " " " ..	—	—	1.0 a.m., 10.5 a.m., 5.0.
OFN	11.980	25.04	9.20.	Vatican City			
French Equatorial Africa				HVJ	6.190	48.47	9.15.
Brazzaville	11.970	25.06	9.45.	LONG- AND MEDIUM-WAVE TRANSMISSIONS			
India				Ireland	kc/s	Metres	
VUD2/3 (Delhi) ..	9.590	31.28	2.30, 5.50.	Radio-Eireann ..	565	531	2.40‡, 7.45‡, 11.0‡, 11.5‡.
VUD4	11.830	25.36	10.0 a.m., 2.30, 5.50, 7.15.	U.S.S.R.			
VUD3	15.290	19.62	10.0 a.m.	Moscow 1	172	1,744	12.0 midt.
Iran				Bakou	200	1,500	12.0 midt.
BQB (Teheran) ..	6.155	48.74	8.30.				
Japan							
JZJ (Tokio)	11.800	25.42	11.30.				
JLG4	15.105	19.86	11.30.				

It should be noted that the times are two hours ahead of GMT. and are p.m. unless otherwise stated. The times of the transmission of news in English in the B.B.C. Short-wave Service are given on the preceding page.

* Saturdays only. § Saturdays excepted. † Sundays only. ‡ Sundays excepted.

Servicing Equipment and Its Uses

Part II.—Test Oscillators

By "SERVICE"

NEXT to the analyser, the service oscillator is the most important piece of service equipment. No modern superheterodyne receiver can be efficiently and quickly overhauled without it, and yet there are many service-men who fight shy of using it, or, if they do employ it in their workshops, do not reap the full advantages of all its applications.

The instrument with which we are concerned is variously called a Signal Generator, Test Oscillator or Modulated Oscillator. All cater for the same need and provide a signal of the required frequency (wavelength), which may be fed into the various circuits of a receiver for test and alignment, but the term Signal Generator is generally reserved for instruments used for more accurate work than ser-

vic-ing. They are larger and not so portable, and have to be looked after if they are to maintain their keen calibration.

The controls of a service oscillator comprise the tuner for selecting the required frequency, the frequency band switch (or wavechange switch, as it would be called in a receiver), and the attenuator which controls the strength of the output from the oscillator, as does the volume control in a receiver.

For the benefit of beginners it may be said that the service oscillator is nothing more than a very small transmitting station, of which the wavelength or frequency may be adjusted; also, the power of the output can be controlled by the attenuator.

A modern all-wave oscillator will cover a wavelength range of from 5 to nearly 4,000 metres so that the short-, medium- and long-wave circuits of a receiver may be trimmed. In addition, the IF circuits of superheterodyne receivers may be ad-

justed. Frequencies of from 80 to 200 kilocycles (corresponding to long waves of approximately 1,500 to 2,750 metres) are often required for earlier types of receivers.

One of the difficulties confronting the newcomer to radio repair work is that the various instruction books which accompany the servicing equipment when it was first purchased cannot be found. He is thus without any guidance as to the best method of using the instrument, and, in many cases, without knowledge of the functions of the various controls. It may be of assistance, therefore, to briefly go through the specification of a typical all-wave oscillator as shown in the photograph, reviewing each control and its function in turn.

First there is the on-off switch to the left by which the valves in the instrument are switched on and off. The oscillator may be mains driven or derive its energy from internal batteries.

To the right of the on-off switch will be seen the wave-range control. In this particular instrument there are six ranges covering from 5 to nearly 4,000 metres.

In the centre at the bottom of the front panel is the modulation control, which allows the signal from the oscillator to be modulated either by the internal circuits of the oscillator or from an external source.

At the extreme left bottom corner will be seen a socket labelled "Ext. Mod." Into this socket may be fed the output from a pick-up or from an audio-frequency oscillator. This signal will be superimposed upon the output from the oscillator just as the programme from a studio is superimposed upon the carrier wave of a broadcasting station.

In some part of the specification of an oscillator it will be stated that a modulated or unmodulated output may be obtained. For everyday servicing where an output meter is used a modulated output is required.

An unmodulated output can only be used with a great deal of disarrangement of the receiver chassis wiring and use of sensitive meters, and this is not worth while unless the outputs from individual RF and IF stages are being



A typical all-wave service oscillator, with artificial aerial units.

investigated. This is seldom necessary for servicing, so that the newcomer need not concern himself about how to employ an unmodulated signal but use a modulated output from his oscillator and an output meter to show him the results of the adjustments to the various trimmers in the receiver.

Reverting back to the modulation control it will be seen that there is a third midway position designated "Audio." When the control knob is in this position the output from the oscillator is a low frequency signal, which can be fed into the pick-up sockets of a receiver or amplifier for testing the AF stages.

The third control at the bottom of the oscillator front panel is the attenuator control. In some instruments a curve is provided with the approximate voltage output of the oscillator plotted against the numbers of the attenuator dial positions, so that for any particular waverange a rough idea of the voltage of the signal being fed into the receiver being tested may be known.

Using the Attenuation

This is a feature which is not only necessary when trimming AVC circuits but is also useful for comparing the sensitivity of a receiver before and after servicing. For the same output from the receiver the attenuator control would be a lower setting after servicing than before, thus showing that the set is more sensitive.

The last control at the bottom of the oscillator is the toggle switch which is labelled "HIGH" and "LOW." This refers to the power of the output in broad terms. When the switch is in the "HIGH" position a very large output is obtained for forcing the signal through circuits which are so badly out of alignment that the normal output from the oscillator would be insufficient to operate an output meter or give any reproduction from the loud speaker. With this high output the circuits can be roughly adjusted or any other investigations made, and the switch can then be adjusted to the "LOW" position which gives a normal output controlled by the attenuator for aligning receiver circuits.

Finally, in the centre of the front panel of the oscillator there is the tuner control which varies the frequency or wavelength of the output between the two extremes of any particular range.

Lying in front of the all-wave oscillator shown in the photograph are two accessories which are known as

"dummy aeri-als." One is for the short-wave ranges, while the other is for the long-wave ranges. As their name implies, they are artificial loads which have the same effect upon the receiver circuits to which they are connected as would a normal aerial, so that the circuits are adjusted under working conditions.

It will be appreciated from the above that what with the controllable output of the service oscillator and the ability to have either a modulated or unmodulated signal that the instrument is very useful for the general investigation of receiver faults.

It is in this sphere that the newcomer can acquire very rapidly a thorough working knowledge of the application and use of the service oscillator, and we will, therefore, consider its application as a fault-finding medium as well as for circuit adjustment.

The first step is to inject an audio-frequency signal into the grid circuit of the output valve, which may often be easily accomplished by connecting the service oscillator between chassis and the grid pin of the valve if this is slightly withdrawn from its valve holder.

If the audio-frequency output from the oscillator is heard at good strength from the loud speaker of the receiver, the associated circuits of the output valve are satisfactory, and the test lead may be disconnected from the output valve and reconnected to the grid circuit of the preceding AF stage. In most modern receivers this will be the triode portion of the second detector valve.

Of course, connecting the lead between the grid of the valve and the chassis may in some instances upset the biasing arrangements, and if a glance at the circuit diagram of the receiver shows that this is so then in the case of the output valve the test may be made between the grid and cathode pins of the valve or the valve holder connections if accessible.

If the signals are still obtainable after the second test, then the output from the service oscillator may be changed to the frequency of the IF amplifier, and this output connected to the various IF stages in turn just as if these circuits were being lined up. It is just as well actually to re-trim the circuit while this test is being made, especially if one of the tests fails to produce the signal, indicating that the fault lies between that test point and the previous one.

The reason for trimming an apparently dead circuit is that sometimes the lack of signals may be due to a

shorting IF trimmer condenser. Manipulation of the trimmer will often show up the fault by intermittent operation as the trimmer screw is rotated.

Assuming, however, that signals are still obtainable, then the remaining procedure is to carry out the aligning instructions as given in the service manual for the receiver, as this will progressively necessitate the connecting of the output from the service oscillator to the various circuits until the aerial coils are reached. Of course, before this final stage is gained, the fault will have shown up. When it does, and after it has been cleared, it only remains to trim up the circuits from that point towards the aerial terminal for the receiver to be not only up to standard with regard to its ability to reproduce signals but also it will be at its maximum efficiency with regard to circuit alignment.

It is essential to use a specially designed insulated trimming screwdriver when making adjustments to trimming condensers or the movable core of inductively tuned circuits. An ordinary screwdriver with a long metal blade will have such an effect upon the circuit that every time it is taken away after an adjustment is made, the output from the circuit will change and it will be out of alignment.

Notes on Trimming

When the operation and application of the service oscillator has been appreciated by practise along lines suggested above, the thorough trimming of a receiver may be attempted. Manufacturers' service manuals give trimming instructions, or at least essential details concerning the value of the IF and the order in which the trimmers are to be adjusted. The following notes must necessarily be of a general character because different circuits require slightly different procedure.

For the very best results to be obtained from the modern receiver extremely critical balance must be preserved and adjustments must be made to compensate for variations produced by the slight changes in the electrical characteristics of the components.

Any error in the alignment of the tuned circuits of a receiver will result in reduced selectivity and sensitivity, especially at the lower end of the medium-wave scale. For this reason RF ganging adjustments are nearly always made with the receiver tuned to about 220 metres.

The output of the oscillator is taken through a screened lead, and it is not

Servicing Equipment and Its Uses— advisable to lengthen this lead. The "earth-side" clip should in most cases be clipped to the chassis of the receiver under test, whilst the "high side" goes to grid or aerial according to the test to be made.

It is of the utmost importance that when working on any receiver connected to DC mains the output lead (chassis side) of the oscillator should be connected to the true earth terminal (if provided) or to the chassis only through the medium of a 0.1-mfd. condenser. If injecting into an anode or the internal wiring of a DC or "universal" mains receiver, it is advisable to insert a 0.0001-mfd. condenser between the high side lead of the oscillator and the receiver. This is to prevent shocks from the mains supply which is connected to the chassis of DC and AC/DC.

Reducing Input

When trimming high-gain receivers it may be found that even with the attenuator at its lowest setting there is too much output from the oscillator. In this case attach the clip of the "high side" lead to the insulation of the wire in question instead of to the actual wire.

Always work with as low an output from the oscillator as possible. When a receiver incorporates AVC the input should be kept low enough to prevent the AVC characteristic from affecting the output from the receiver.

Although the effect of each adjustment may be judged by ear, an output meter will enable greater accuracy to be obtained. It should be connected where advised in the service manual. The ear cannot be depended upon to record slight changes in the strength of output from a receiver and for all retrimming operations an output meter should be used. Modern receivers are so compact that the old practice of breaking into the second detector anode circuit with a milliammeter is not practicable and the use of an output meter connected to the loudspeaker is far more convenient.

An AC voltmeter may be used if no proper meter is available. An output meter is really only an AC voltmeter calibrated in watts. A high-range AC voltmeter or a high-impedance output meter should be connected across the primary of the output transformer while a low range (0-1V) AC voltmeter or low-impedance output meter should be connected across the speech coil of the loudspeaker.

As a receiver is trimmed, its output will increase and the service oscillator attenuator must be adjusted to give a

reading of approximately 50mW on a high-impedance output meter or about 0.5V on the low-range voltmeter. The receiver manufacturer's service manual will generally help on this point.

Do not use the visual tuning device of a receiver as an output indicator unless specifically instructed to do so in the service manuals. The AVC may produce misleading indications.

Having discussed the use of the oscillator in general terms, we will consider its application more specifically, starting with a simple TRF receiver. Here the main trouble is likely to be that after roughly trimming the circuits, it may be found that one trimmer is screwed fully home, or fully unscrewed, whereas definite optimum settings are obtainable for the others. If one trimmer has to be screwed up tight, ganging is being attempted with too much trimmer capacity. If this condition is found, unscrew all trimmers slightly and retune to oscillator note (slightly higher dial reading).

Reverse the above proceedings if a trimmer must, in order to balance, be fully unscrewed.

As the trimmers are connected across

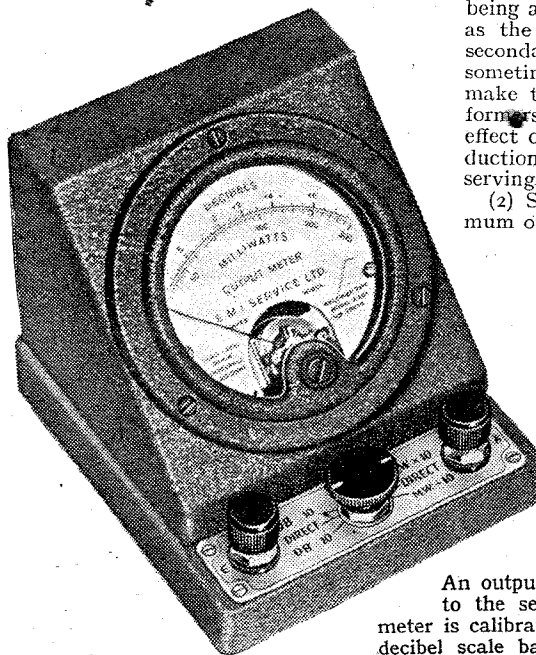

An output meter, a companion instrument to the service oscillator. This particular meter is calibrated in milliwatts and also has a decibel scale based on a zero value of 50 mW.

the tuning coils they cause additional capacity to be added to the tuned circuits and it will be apparent that too much capacity in the trimmers will cause loss of tuning range, i.e., difficulty in reaching lowest wavelength.

If the ganging runs out of step as the wavelength is increased, this may be due to strain in the ganged condensers; see that the fixed and moving vanes are perfectly parallel when fully engaged.

The slit end-vanes of each section of the ganged condenser rotor are cut so that by slightly staggering the sectors a smoothing tuning curve is obtained. If

tracking is out of alignment on one section only of the tuning scale this may be due to one sector of an end-vane having been bent out of place.

As the long-wave coils are shorted out when the receiver is operated on medium waves, any adjustments made to the long-wave trimmers will not upset the medium wave ganging. For trimming long-wave coils the receiver and oscillator should be tuned to about 1,200 metres.

The alignment of superheterodynes will now be considered in detail. In this type of set the adjustment of IF circuits must always precede the RF trimming. Where the first valve serves as a combined first detector and oscillator sufficient coupling will be obtained by connecting the output from the oscillator between the control grid of the valve and chassis.

The grid of this valve may be brought out to a terminal on the top of the valve; adequate coupling may be obtained by attaching the oscillator output clip to the insulated portion of cap or lead to the valve.

The order of the trimming adjustments will be along the following lines:—

(1) Set the tuning condenser of the oscillator to the intermediate frequency of the receiver. Reference to the service information issued with the instrument being adjusted must be carefully studied as the frequencies of the primary and secondaries of each IF transformer are sometimes staggered. This is done to make the resonance curve of the transformers substantially flat, which has the effect of improving the quality of reproduction while at the same time preserving the selectivity.

(2) Set the attenuator to give maximum output.

(3) Switch on the receiver and set the volume control to maximum. If the radio instrument is functioning properly a deflection will be obtained on the output meter.

(4) Reduce the output of the oscillator by means of the attenuator until the output meter reading falls to a level where the needle registers about $\frac{1}{2}$ scale.

(5) Now adjust the secondaries of the IF transformers in

the order given in the manual. Always begin by tuning the secondary which is electrically nearest to the second detector valve. If the circuits are to be staggered these coils might be adjusted to, say, 125 kc/s in early types of receivers by means of their trimmers until maximum deflection is obtained.

(6) Next tune the primary coils of the IFT's to, say, 123 kc/s. Again, the coil which is electrically nearest to the output of the receiver must be tuned first. In present-day receivers of the cheaper type, all IF circuits are adjusted to the same frequency—generally 465

kc/s. This is termed peaking the circuits instead of staggering them. The selectivity of staggered circuits can be improved by peaking them but at the expense of quality.

Turning to the RF circuits, it is important that some form of aerial be connected to the instrument to be re-ganged in order to secure a normal operating condition if no dummy aerial is provided with or incorporated in the service oscillator. Procedure on medium waves will be as follows for most types:—

(1) Loosely couple the oscillator to the aerial lead-in by clipping the output lead of the oscillator to the chassis of the receiver.

(2) Adjust the ganged condenser so that the vanes are disengaged. This does not necessarily mean that the moving vanes will be hard up against the stop position. Consult the service instructions for the receiver in question in order to ascertain the pointer positions and physical position of vanes for a given scale reading.

(3) Switch on the receiver and the oscillator and tune both to 220 metres.

(4) Unscrew the first tuned circuit trimmer to minimum capacity.

(5) Adjust the trimming condenser on the beating oscillator section of the ganged condenser to give maximum deflection of output meter needle. If the oscillator note is heard at two positions when adjusting the trimmer, the position nearest minimum capacity of the trimmer must be chosen.

(6) Check the position of scale pointer to make sure that reading of oscillator and receiver scales agree.

(7) Now tune the service oscillator to give, say, a 250-metre signal. This actual wavelength may vary a good deal, depending on the design of the radio instrument, and the manufacturer's instructions must be followed. Tune the

radio instrument to the oscillator signal and adjust the trimmer of the section of tuning condenser which tunes the grid circuit of the RF amplifying valve. Always trim the grid tuning circuit before attempting to adjust the aerial circuit. Adjust trimmer of the second variable condenser section to get maximum response to oscillator signal. Rock the ganged condenser to ensure that the correct position has been obtained.

(8) The aerial circuit trimmer must now be adjusted to give maximum deflection on meter.

Switching over to long waves, tune oscillator to give 1,000-metre signal and adjust the long wave trimmer condenser(s) for maximum output of meter at the same time rocking the ganged condenser. When all trimmers have been attended to go over all the adjustments again in order to check each one.

On short waves the procedure follows closely that described above for MW and LW. Adjustments will be more critical and greater care must be taken in making them. The settings of the oscillator and receiver tuning points will be given in the manufacturer's service notes.

There is one thing which must be looked out for in short-wave circuits and in some medium-wave circuits, and that is inductance trimming. With present-day push-button receivers inductance trimming is generally done by movable iron-dust cores, but where circuits are manually tuned, loops of wire or straight lengths of wire running parallel to each other will sometimes be met with. These should not be tied up or they will probably have very serious effect upon the sensitivity of the circuit at certain points of the waveband. They are generally mentioned in the manufacturer's service manuals and should not be touched unless full instructions as to their adjustments are available.

The "Fluxite Quins" at work

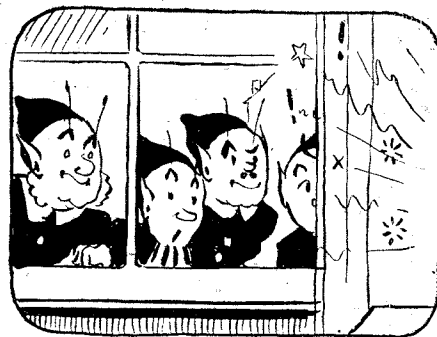

"What 'orrible language," cried EE,
 "Someone being murdered strikes me!"
 "It's a bloke soldering sets,
 Without FLUXITE, me pets,
 He needs us, come on, all you three."

See that FLUXITE is always by you—
 in the house—garage—workshop—
 wherever speedy soldering is needed.
 Used for 30 years in Government
 works and by leading engineers and
 manufacturers. Of Ironmongers—in
 tins, 4d., 8d., 1/4 and 2/8.

Ask to see the FLUXITE SMALL-
 SPACE SOLDERING SET—compact
 but substantial—complete with full
 instructions, 7/6.

Write for Free Book on the art of
 "soft" soldering and ask for Leaflet
 on CASE-HARDENING STEEL and
 TEMPERING TOOLS with FLUXITE.

BOOKS ON WIRELESS

issued in conjunction with "The Wireless World"

	Net Price	By Post
"FOUNDATIONS OF WIRELESS," by A. L. M. Sowerby, M.Sc. Second Edition Revised	5/-	5/6
"RADIO LABORATORY HANDBOOK," by M. G. Scroggie, B.Sc., A.M.I.E.E. Second Edition Revised and Enlarged...	10/6	11/1
"WIRELESS SERVICING MANUAL," by W. T. Cocking, A.M.I.E.E. Sixth Edition Revised and Enlarged	6/-	6/6
"HANDBOOK OF TECHNICAL INSTRUCTION FOR WIRELESS TELEGRAPHISTS," by H. M. Dowseit, M.I.E.E., F.Inst.P., M.Inst.R.E. Sixth Edition Revised	21/-	21/9
"WIRELESS DIRECTION FINDING," by R. Keen, B.Eng. Hons. Sheffield, A.M.I.E.E. Third Edition	25/-	25/9
"RADIO DATA CHARTS," by R. T. Beatty, M.A., B.E., D.Sc. Second Edition	4/6	4/11
"TELEVISION RECEIVING EQUIPMENT," by W.T. Cocking, A.M.I.E.E.	8/6	9/-
"RADIO INTERFERENCE SUPPRESSION," by Gordon W. Ingram, B.Sc.	5/-	5/4
"LEARNING MORSE." Seventh Edition	6d.	7½d.
"RADIO DESIGNER'S HANDBOOK," Edited by F. Langford Smith, B.Sc., B.E.	8/6	9/1
"THE WIRELESS WORLD" GREAT CIRCLE PROJECTION MAP	2/-	Post free

Obtainable from Leading Booksellers and Railway Bookstalls or by post (remittance with order) from

ILIFFE & SONS LTD., Dorset House, Stamford Street, London, S.E.1

TO CYCLISTS! Your wheels will NOT keep round and true unless the spokes are tied with fine wire at the crossings AND SOLDERED. This makes a much stronger wheel. It's simple—with FLUXITE—but IMPORTANT.

THE FLUXITE GUN

is always ready to put Fluxite on the soldering job instantly. A little pressure places the right quantity on the right spot and one charging lasts for ages. Price 1/6, or filled 2/6.

FLUXITE LTD.
 (Dept. W.W.),
 BERMONDSEY
 STREET, S.E.1

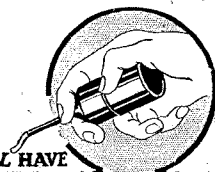

ALL MECHANICS WILL HAVE

FLUXITE

IT SIMPLIFIES ALL SOLDERING

RANDOM RADIATIONS

Pooling Service

THE servicing of wireless sets has grown increasingly difficult since the war started owing to the calling up of so many of the men who did the work in peacetime. Hence I'm glad to hear that a start has been made by some wireless dealers in pooling their service jobs. Here's how it works. A group of dealers in one district gets together and establishes central workshops—possibly they use workshops already belonging to one of them if these are big enough. They pool not only their testing equipment and their tools but also their service-men for fitting out and staffing the central workshops. All jobs, except the very simple ones which can be tackled locally, are sent in to the common servicing centre. In this way the best use is made of the available men and equipment. Jobs are done more quickly and more efficiently than they could be if individual dealers with depleted staffs undertook them. I hope that the system will extend rapidly, for I'm sure that it is the best possible way of dealing with the present difficult situation.

Some Extension

ONE small detachment of mine functions about a mile from headquarters. They can't have a broadcast receiver because they are on duty, but I wanted to be able to let them hear such of the news bulletins as came through at times when there wasn't much doing in the way of hostilities. Purely as an experiment, and not expecting any results, I installed a small loudspeaker and connected it direct to the "extension" terminals of the headquarters broadcast set by means of the existing telephone line. As I've said, the distance is a mile or so, which makes the circuit some two miles long, out and home. The telephone line is of the usual Army type, laid across country on the tops of hedges, and so on. Its total resistance is 120-130 ohms. What kind of reception would you have expected from the distant loudspeaker? I'm not going to say that the volume was great—it wasn't. Still, to my surprise, it proved to be sufficient to be clearly audible at 6-8ft. from the loudspeaker. Half a dozen men, in fact, can listen to the news. Naturally, we're constructing a single-valve amplifier for boosting purposes. It will be finished as soon as I can get hold

By "DIALLIST"

of a suitable output transformer and a few other small bits and pieces. I have them right enough, but they're at my home; so the completion of the amplifier must wait until my next short leave comes along. Meantime, we are not doing too badly with the unboosted signals, and the troops agree that any kind of reception of the news is better than none at all.

Surprises

The receiving set is an Ekco superhet, which has done good work almost since the beginning of the war. Just what the output circuit is I don't know, for the firm doesn't publish details of the innards of its sets—and I haven't had the curiosity to investigate very closely. The distant loudspeaker, though, is of the 2-3-ohm type, and it is connected direct to the telephone line wires without any intervening transformer. I expected that if it worked at all reproduction would be at bare headphone strength. Hence my surprise when the loudspeaker almost lived up to its name. Still, one does get surprises at times in wireless; arrangements that don't look as if they ought to work at all do work—and others that you'd expect to work just don't.

Fifty-six Megacycles

A KIND reader living near Reading replies to the question I asked last month about reports of transatlantic reception at or near the 1939 sunspot maximum. There appears to have been one authenticated instance of reception of a 56-megacycle American station in this country and one of reception in California of a station in these islands. I thought that there were more. Very interesting, in view of the theoretical skip distances given by a correspondent in last month's *Wireless World*, are the records that this reader sends of reception of 56-megacycle signals at places far beyond visual range, but at the same time a long way inside what might have been expected to be the skip area. Amateurs in France, Belgium and Holland worked with their opposite numbers in this country in 1939. My correspondent describes this as an extension of

the ground-wave range due to temperature inversion a mile or so above ground level. But what of the reception from Austria and Germany recorded in 1937? Or that from Sweden and Switzerland in 1938? I should not be surprised if history repeated itself to some extent in the matter of the "Below Ten" wavelengths. In not-so-very-old textbooks you may find statements that the short waves, that is those below a hundred metres, were never likely to be of any commercial use for long-distance transmissions. You know the continuation of that story! Is it not possible that by a careful choice of frequencies to suit times and seasons the UHF bands may one day play an important part in communications?

HTB's

SOME people tell me that they have difficulty in obtaining high-tension battery replacements, whilst others report no trouble at all. The demand for HTB's has, I believe, gone up greatly since the summer of 1939. There are two reasons for this. More sets are in use in places (or in houses) without mains electric supplies. And most battery receivers (like their mains counterparts) are worked for more hours a day than they were in pre-war times. Actually batteries of standard sizes, shapes and tappings are not unduly hard to come by. Those who complain about difficulties in finding replacements are more often than not owners of receivers—some of old types—which require special HTB's. At one time designers of battery receiving sets had a passion for turning out models requiring odd shapes and sizes in HTB's! When I say "requiring" I don't mean that such batteries are absolutely essential. They must be used if you want to fit them into the cabinet and insist on retaining the existing HT and GB leads and plugs. But as a rule there is little difficulty about altering leads and plugs to suit a standard HTB, plus, if necessary, a separate grid bias battery. And if they won't go into the cabinet? Not much real difficulty here, either. What I have often done is to provide a separate HT and GB battery box, which either lives on top of the cabinet, or, better, goes beneath it, forming a kind of plinth for it to stand on. In these times, when out-of-the-way HTB's are difficult to get, it is probably wise to convert any receiver designed for one of them so that it will work from the standard—and much more readily obtainable—article.

UNBIASED

Diversity Reception at Home

IT has often been a source of wonderment to me why people leave their sets on at all hours drooling out the daily doses of dreary dissertation and doleful dirges churned out by the B.B.C. for our alleged edification and entertainment respectively.

It can hardly be laziness or carelessness, for, after all, nobody leaves the water tap running all day.

While on fire-watching duty the other night I was pondering this problem while fitfully dozing in company with the female whom fate and the local warden has decreed shall share my lot on these occasions. Eventually I put the problem to my companion, as I knew her to be a daily-drool addict, and to my surprise she was instantly able to provide me with the answer to the problem.

The reason that people left the set on all day, she said, was not because they liked it, but because it was such a blessed relief when they finally turned it off. When I argued that if

By FREE GRID

nightly in a vain endeavour to titillate their ear-drums with transatlantic tintinnabulations. The faint cries, all but drowned out by the background of roaring noise, which are emitted by these overstrained sets, has so moved me that for some time past I have been operating a co-operative reception scheme in my neighbourhood which some of you might like to try out in your own districts. Briefly, I have made an arrangement with set owners dwelling within half a mile or so of me whereby all their aerials are coupled by transmission lines to my set on the principle of the MUSA aerials used by the G.P.O. for their "diversity reception" of American transmissions, a system which was described by "Cathode Ray" in the December 8th, 1938, issue of *The Wireless World*. As a result, I am able to supply my neighbours with non-fading and noise-free world-wide programmes by means of ordinary loud-speaker extension leads.

Scientific Slovenliness

I WAS very pleased to read the stern words addressed to his readers by the Technical Editor of *The Wireless Engineer* in a recent issue of that journal in which he severely castigated that large class of people who are addicted to the use of slovenly half-truths like "50 cycles" when they really mean "50 cycles per second." There is far too much of that sort of thing going on, and I have always endeavoured to correct it whenever I have come across it.

Women are, as might be expected, the chief offenders, and only the other day Mrs. Free Grid provided a striking example of it when she announced that a certain newly released model of the human species in which she is interested weighed seven pounds. My gently worded rebuke, "avoidupois or troy?" merely provoked an answer which was neither intelligent nor intelligible. It is true that troy weight is seldom, if ever, used for weighing babies, but that is no excuse for omitting the scientifically accurate qualifying adjective, "avoidupois," any more than it is excusable to omit the adjectival expression "per second" just because it is not customary to plot cycles against minutes or hours.

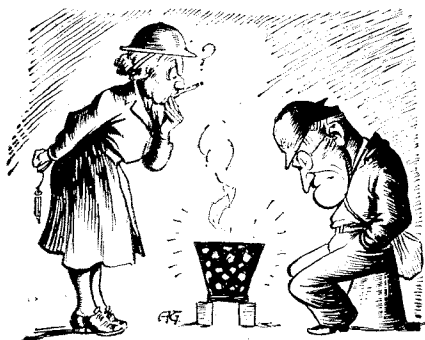

Waiting for Hitler

this were so, surely it would provide still greater relief if they never turned it on at all, she pointed out very logically that unless and until there had been pain or discomfort there was nothing from which to obtain relief.

I must say that this sounded very convincing, even though it rather reminded me of the story of the man in the lunatic asylum who, when asked why he kept on hitting himself over the head with a chunk of wood, gave exactly the same reply.

I suppose it is much the same sort of thing which induces people with an inadequately designed short-wave section to their sets to roam the ether

VORTEXION

50w. AMPLIFIER CHASSIS

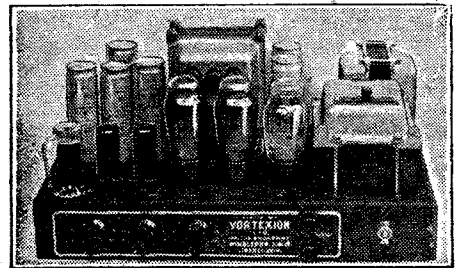

A pair of matched 6L6's with 30 per cent. negative feed-back is fitted in the output stage, and the separate HT supplies to the anode and screen have better than 4 per cent. regulation, while a separate rectifier provides bias.

The 6L6's are driven by a 6F6 triode connected through a driver transformer incorporating feed-back. This is preceded by a 6N7 electronic mixing for pick-up and microphone. The additional 6F5 operating as first stage on microphone only is suitable for any microphone. A tone control is fitted and the large eight-section output transformer is available in three types—2-8-15-30 ohms; 4-15-30-60 ohms or 15-60-125-250 ohms. These output lines can be matched using all sections of windings and will deliver the full response (40-18,000 c/s) to the loud speakers with extremely low overall harmonic distortion.

CHASSIS with valves and plugs	£17 10 0
Goodmans P.A. Speakers in stock.	
Paper Maché Horn Speakers	£6 6 0
Moving Coil Microphones	£5 5 0
Chromium Microphone Stands from	15 0

Many hundreds already in use for
A.R.P. & GOVERNMENT purposes

15w. AC & 12-VOLT DC AMPLIFIER

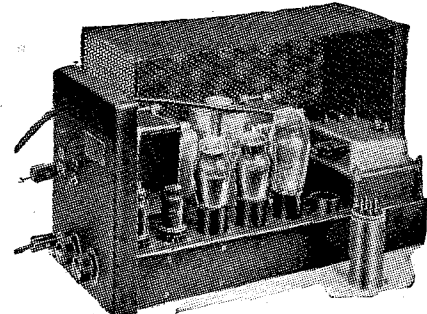

TYPE CP20

This small Portable Amplifier operating either from AC mains or 12-volt battery, was tested by "THE WIRELESS WORLD," October 1st, 1937, and has proved so popular that at Customers' demand it remains unaltered except that the output has been increased to 17.2 watts and the battery consumption lowered to 6 amperes. Read what "The Wireless World" said:—

"During tests on output of 14.7 watts was obtained without any trace of distortion so that the rating of 15 watts is quite justified. The measured response shows an upper limit of 18,000 c/s and a lower of 30 c/s. Its performance is exceptionally good. Another outstanding feature is its exceptionally low hum level when AC operated even without an earth connection. In order to obtain the maximum undistorted output, an input to the microphone jack of 0.037 volt was required. The two independent volume controls enable one to adjust the gain of the amplifier for the same power output from both sources, as well as superimpose one on the other or fade out one and bring the other up to full volume. The secondary of the output transformer is tapped for loud speakers or the impedances of 4, 7.5 and 15 ohms." Prices

AC and 12-volt CHASSIS with valves, etc.	£12 12 0
AC only CHASSIS with valves, etc.	£8 18 6

Gauze Case for either chassis, 12/6 extra.

Plus 20% War Increase.

Delivery Prompt delivery on "Priority 1A" orders.

Vortexion Ltd., 257, The Broadway,
Wimbledon, S.W.19. Phone: LIBerty 2814

RECENT INVENTIONS

A Monthly Selection of the More Interesting Radio Developments

"VISUAL" DIRECTION-FINDERS

THE object is to show the bearing of a distant wireless transmitter by the position of a single spot of light on the fluorescent screen of a cathode-ray tube. The signal picked up on a frame aerial A, which is constantly rotated at a speed, say, of 20 revs. per second, is combined with that received by a non-directional aerial B, in a tuned circuit T.

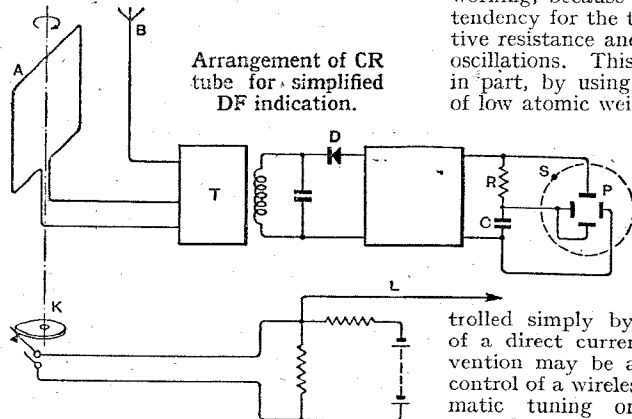

The output from the latter is then rectified at D and applied, through a phase-splitting circuit R, C, to the deflecting plates of a cathode-ray tube P. In the ordinary way, this would cause the electron beam to trace out the circular path shown in dotted lines on the fluorescent screen, the trace being continuously visible.

According to the invention the continuous trace of light is converted into one single spot S, which appears on the screen at a point indicating the direction of the distant transmitter. For this purpose, a potential sufficiently negative to cut off the electron stream is normally applied to the grid of the CR tube by a lead L from a DC source. The negative bias is, however, removed once in each revolution of the frame aerial by a cam K mounted on the aerial shaft in line with the plane of the windings. Since the position of the spot keeps step with the varying phase of the signal current as the frame aerial rotates, its momentary appearance, when the bias is removed, will indicate both the direction and "sense" of the distant beacon station. The speed at which the spot reappears keeps it constantly visible.

Marconi's Wireless Telegraph Co., Ltd.; C. S. Cockerell and G. P. Parker. Application date, March 14th, 1939. No. 527495.

VARIABLE-INDUCTANCE TUBES

IT is known that a glow-discharge tube shows a marked frequency response to the current passing through it. The reason is that the tube behaves as a

resistance connected in series with an inductance, the value of the latter depending upon the direct-current component of the discharge stream. Knowledge of this fact has led to the use of such tubes, say, for regulating the transmission characteristics of a low-pass filter.

The problem is, however, not so simple when it comes to high-frequency working, because there is then a marked tendency for the tube to develop a negative resistance and to generate sustained oscillations. This difficulty is overcome, in part, by using a tube filled with gas of low atomic weight, such as hydrogen, and in part by shunting the tube with a high-inductance coil. The tuning of a high-frequency circuit containing such a combination can then be varied or controlled simply by regulating the value of a direct current fed to it. The invention may be applied to the remote-control of a wireless set, or used for automatic tuning or variable selectivity control.

L. de Kramolin. Convention date (Germany), April 30th, 1938. No. 527649.

PHOTO-ELECTRIC CELLS

THE cathode of a photo-electric cell is coated with an alkali metal and simultaneously bombarded with atomic hydrogen. This is stated to increase its response to the action of light.

The alkali metal may be vaporised and exposed to atomic hydrogen in that state, or the molecular hydrogen may be bubbled through the metal when in a molten condition, and the resulting vapour allowed to expand before being applied to the surface of the electrode. The latter is finally subjected to bombardment by a stream of electrons projected from a "gun" of the kind used in a cathode-ray tube. This is said to increase the sensitivity still further, and also to stabilise the performance of the electrode.

The Board of Trustees of the University of Illinois. Convention date (U.S.A.), January 5th, 1938. No. 527353.

VARIABLE SELECTIVITY

IT is sometimes useful to be able to vary the selectivity of a wireless receiver between what one may call abnormally wide limits. For instance, in certain forms of commercial, as distinct from broadcast receivers, it is an advantage to be able to change from a selectivity wide enough to receive telephony sidebands, to a razor-edge tuning capable of distinguishing telegraphic morse signals

against a background of severe interference. Similarly in DF work the band of frequencies required to distinguish the "characteristic" signal of a beacon transmitter is much too broad to allow the best results to be obtained when flying along a beam, or even when taking bearings on the transmitter.

A superhet set is made capable of showing a resonance response of this kind by including in one of the intermediate-frequency stages a special feedback circuit comprising a piezo-electric crystal shunted by an inductance, a capacity and a variable resistance, all in parallel. Preferably the crystal network is inserted on the cathode "leg" of a pentode amplifier, so that the feedback is negative, though positive reaction (through a similar network in the anode circuit) may be used. The selectivity is controlled by varying the shunt resistance.

Marconi's Wireless Telegraph Co., Ltd.; N. M. Rust, and E. F. Goode-nough. Application date, 12th January, 1939. No. 527902.

VARYING INTERELECTRODE CAPACITY

DURING the warming-up period which occurs after a valve has first been switched into operation, a gradual change takes place in the interelectrode capacities. Since these are usually in parallel with the RF circuits, a corresponding drift in frequency is likely to occur. The effect has, for instance, been observed to last over a period of 40 minutes, the detuning of the associated circuits being at first rapid, but coming more slowly to a constant value.

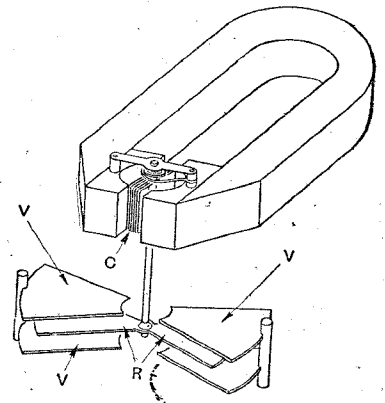

Method of compensating for frequency drift.

As a remedy, a thermocouple consisting of two wires of different but suitable material is connected, say, to the anode of a transmitting valve, so that, as the heat increases, a thermoelectric voltage is generated. This is fed to the winding C of a small moving-coil instrument and

COMMUNICATIONS DEPEND....

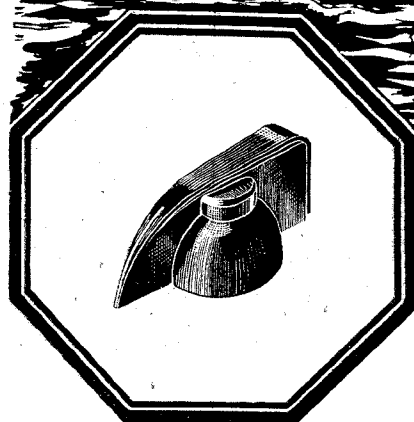

ON SMALL PARTS....

IN countless instances quite intricate pieces of apparatus are wholly dependent on the proved reputation and reliability of their component parts.

All products from the House of Bulgin are pre-eminent for superior design and workmanship, and every article bearing our Trade Mark has to pass exacting and exhaustive tests during the course of its production.

That is why every manufacture of national importance incorporates Bulgin Components.

Let us send you

Our new 128 pp. Catalogue No. 164WW, fully illustrated and with technical and dimensional data. A valuable and comprehensive reference list. Price 9d. post free.

ALWAYS DEPEND ON



REGISTERED • TRADE • MARK

A. F. BULGIN & CO. LTD., BY-PASS RD., BARKING, ESSEX.

Telephone: RIPPLEWAY 3474 (4 lines)

serves to rotate a pair of rotors R into or out of engagement with stationary vanes V, the combination forming a small condenser which is connected in parallel with valve. The shaft is rotated against a restoring spring, the change in capacity value being arranged to neutralise that due to the heating-up of the valve.

Marconi's Wireless Telegraph Co., Ltd., and G. B. Banks. Application date, April 1st, 1939. No. 527433.

"BUNCHING" ELECTRONS

IN the so-called Klystron generator, oscillations of very high frequency are produced by subjecting the electron stream produced in a discharge tube to the action of a magnetic field, which alternately accelerates and decelerates the speed of the individual electrons, so that the stream takes on a "bunched" formation along its length. In this condition the stream is fed into a hollow chamber which is "tuned" to the periodicity of the bunches. In other words, the chamber acts as a resonator in which the bunches of electrons are converted into electrical oscillations of corresponding frequency.

In order to simplify this process, it is now proposed not only to "bunch" the electrons, but also to draw off their energy, as a radio-frequency current, from one and the same resonant chamber.

The Board of Trustees of the Leland Stanford Junior University. Convention date (U.S.A.) January 22nd, 1938. No. 528041.

RECEIVING SETS

THE chassis of a wireless receiver usually carries component parts mounted both above and below the main supporting platform, the wiring being generally located below. For servicing purposes, it may therefore be necessary to unscrew the chassis from its base-board or supporting panel, and to remove it from the cabinet.

To avoid this the chassis is hinged, either at its far or near edge, to a base-board, by pivots which can also slide on inclined guide-rails fixed to the sides of the cabinet. The arrangement allows the chassis first to be withdrawn bodily, and then to be turned to an inverted position, if necessary, outside the cabinet. Or it can, when in the retracted position, be completely removed from the cabinet without having to use a screwdriver or other tool in order more conveniently to carry out any repair.

D. Jackson and Pye, Ltd. Application date, 26th April, 1939. No. 528198.

The British abstracts published here are prepared with the permission of the Controller of H.M. Stationery Office, from specifications obtainable at the Patent Office, 25 Southampton Buildings, London, W.C.2, price 1/- each.

Let the **RAF** make you a Radio/Wireless Mechanic

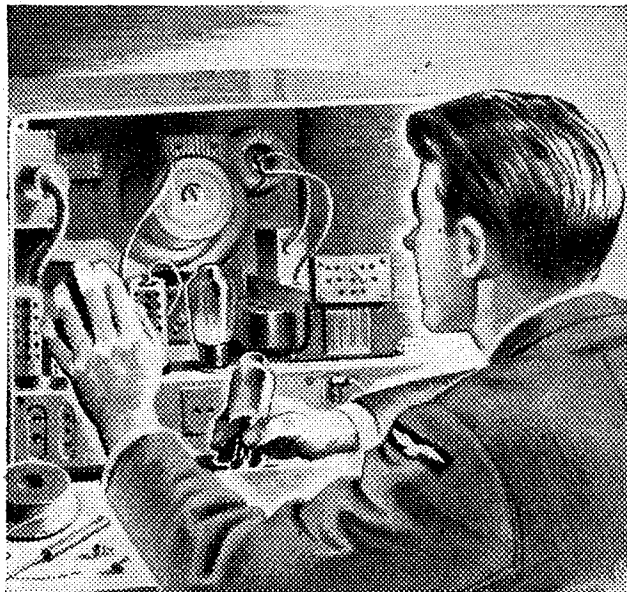

As Britain's air power grows, the need for Radio/Wireless Mechanics increases now, more than ever before, Radio/Wireless Mechanics are needed and they are needed AT ONCE. Keen young men between 18 and 34, interested in the practical side of wireless, should volunteer immediately. They will be trained in the maintenance and repair of the most up-to-date radio and wireless equipment. Theirs will be a responsible job a job upon which depends the safety of the air crews of the R.A.F. When peace returns their training and experience will stand them in good stead in civilian life. Go 10-day to the R.A.F. Section of the nearest Combined Recruiting

Centre (address from any Employment Exchange) and tell them you want to volunteer for immediate duty.

Armourers wanted too!
 There are opportunities for keen men, with a mechanical sense, aged between 18 and 42, willing to be trained to test and maintain air armament, load and fuse bombs, etc. —work that is essential to the offensive power of the R.A.F.

Please send me details of Technical Duties in the R.A.F.

NAME

ADDRESS

To AIR MINISTRY INFORMATION BUREAU, KINGSWAY, LONDON, W.C.2

L·C·R

COSSOR CATHODE RAY APPARATUS

We have been successful in purchasing a limited quantity of Cossor Cathode Ray Equipment which can be adapted to a variety of purposes including Oscilloscopes. This is an opportunity for those engaged in Research and Development work as such apparatus is not now obtainable through normal channels.

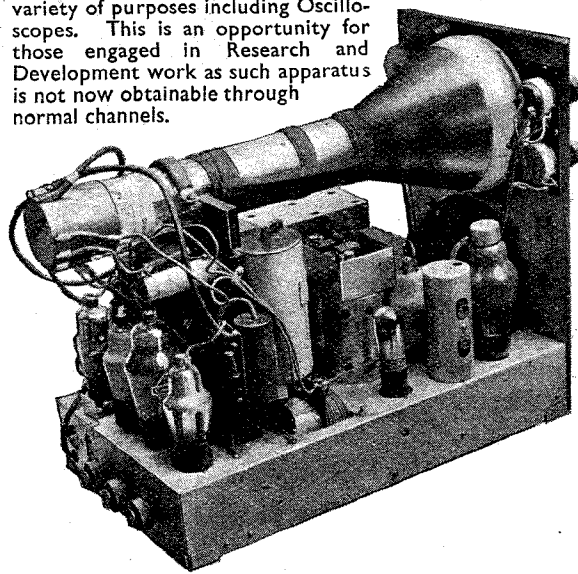

- (1) Complete equipment as illustrated with Cathode Ray Tube, Type No. 3244 **£16 0 0**
 Or complete in walnut table cabinet **£17 0 0**
 (Cabinet 12" x 21" x 16½" supplied separately, 27/6.) Carr. fwd. plus 2/6 for packing.
- (2) As above but with C.R. Tube, Type No. 3221 **£16 15 0**
 (see below) **£18 5 0**
 Or complete in walnut pedestal cabinet **£18 5 0**
 (Cabinet 15" x 20" x 36", also supplied separately at 35/-) Carr. fwd. plus 2/6 for packing.
- (3) Cossor Cathode Ray Tubes. Electrostatic deflection and focus Type No. 3244. Overall length approx. 19", dia. approx. 6" **£7 0 0**
 Type No. 3221. Overall length approx. 20", dia. approx. 7½" **£7 18 6**
 Collection by Purchaser.
- (4) Cossor Television Time Base and Sound Chassis (Television Sound Waveband only) for above Tubes, comprising — H.T. transformer for tube supply, transformer for heater and valves. Eight-inch energised speaker, 13 valves, 7 variable resistances for volume, contrast, trimming, etc., banks of condensers, resistances, etc., etc. On heavy metal chassis, wired ready for use, brand new **£9 10 6**
 Carr. fwd. plus 2/6 packing charge.

PLEASE SEE OUR JULY ANNOUNCEMENT for details of other exceptional offers of Cathode Ray and Radio Equipment and Components.

● **Three further items of interest** ●

- EA50 TELEVISION DIODES. 6.3 v., 0.15 amp. Limits: Vd. max. 50 v., Id. max. 5.0 m.a., Vd. max. (Id. = plus 0.3 μa) — 1.3 v., Vfk. max. 50 v., Rfk. max. 20,000 ohms **10/6**
- RECTIFIERS (by Standard Telephones), 14 v. input, 12 v. output, 1½ amp. **12/6**
- NEW ERIE RESISTANCES. Several Values. 3 w., 1/3, 2 w., 1/-, 1 w., **10c.**

N.B.—Unless otherwise marked, sufficient postage must be included with all orders.

LONDON CENTRAL RADIO STORES
 23, LISLE STREET, LONDON, W.C.2
 GERrard 2969



...get a good job in the Army!

Interesting work — good conditions — good pay — they're all waiting for you if you have a knowledge of radio, or aptitude for training. The Royal Army Ordnance Corps wants men, and wants them urgently, for the installation, maintenance and repair of Radio and Radiolocation Equipment. There are good opportunities for promotion from the ranks. And there is this further advantage — if in civil life you are a radio expert, you can return to your job after the war with a first-hand knowledge of all the very latest developments in radio. (N.B. Even though you are unskilled, this is still your opportunity. You will be given a thorough training at a

Civilian Institute on full pay.) Britain's Radio defences must be kept in 100% working order. That's why you must volunteer TODAY. These are the vacancies:—

	<i>Pay and Allowances</i>	
	SINGLE	MARRIED
Ordnance Mechanical Engineers (Wireless)	£431 p.a.	£504 p.a.
Radio Maintenance Officers - -	£330 p.a.	£460 p.a.
Armament Artificers (Radio) - -	10/3 per day plus clothing, rations, accommodation and family allowance)	
Radio Mechanics (commencing at)	3/9 per day (plus clothing, rations, accommodation and family allowance)	

POST THIS COUPON AT ONCE

To the Assistant Director of Mechanical Maintenance, The War Office (MMI), Room 206, Golden Cross House, Duncannon Street, London, W.C.2.
Please send full details of Wireless Positions in the R.A.O.C.

NAME

ADDRESS

AO1/8/41

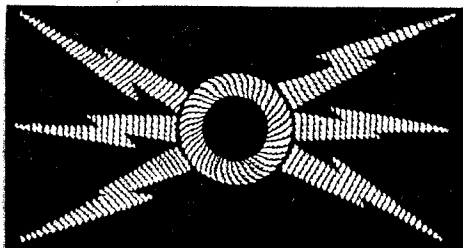

CLASSIFIED ADVERTISEMENTS. The charge is 6- for each paragraph of 2 lines or less, and 3/- for every additional line or part thereof, average 7 words to a line. Each paragraph is charged separately. ADVERTISEMENTS for the September issue are accepted up to First Post on Friday, August 8th, at the Head Office, Dorset House, Stamford Street, London, S.E.1, or one day earlier at provincial Offices.

THE PROPRIETORS retain the right to refuse or withdraw advertisements at their discretion. They are not responsible for clerical or printers' errors although every care is taken to avoid mistakes. Cheques and postal orders should be made payable to Iliffe & Sons Ltd. and crossed. Notes are legal tender and cannot be traced if lost in transit.

ADVERTISERS may have letters, other than circulars, addressed to numbers at this office. The words Box 000, c/o "WIRELESS WORLD" must be paid for and a further 1/- added for registration and forwarding replies. DEPOSIT SYSTEM. Full particulars upon application to the Depos. Dept., "Wireless World," Dorset House, Stamford Street, London, S.E.1.

Ode Partridge No. 7

RADIOLOCATION

'Twas over thirty years ago
When wireless, then in embryo,
Thrilling us with dot and dash
Ate deeply into our spare cash.

* We hunted round for formers, wire,
Wound coils for hours and did not tire,
Waxing tubes, and waxing hot
When wanting bits we had not got.

Complete at last, with headphones tight
We fished around to get a "bite,"
And when the magic signal came
We felt we were ear-marked for fame.

How marvellous was this science then
Which harnessed things beyond our ken,
And who'd have thought that three
decades

Would put such triumphs in the shade?
But yet 'tis so, and now our sons
Can trace the course of flying Huns,
Doom them to annihilation
By means of Radio Location.

N. Partridge

B.Sc., A.M.I.E.E.
King's Bldgs., Dean Stanley St.,
LONDON S.W.1
Telephone: VICTORIA 5035

ARMSTRONG

Opportunity is Passing!

In our July advertisement we pointed out that many readers would have to return to their old hobby of building or modernising their receivers as new ones were not available. In the same issue we offered two complete sets of Coils and I.F. assemblies as fitted to our models RF2PP and AW3P. The former have all been sold.

We still have a limited number of Coils and I.F. Transformers as used in Model AW3P.

Brief Description:

H.F., Aerial and Oscillator Coils covering Short-Medium and Long Wavebands, together with two 465 kc. I.F. Transformers, all in aluminium cans with self-contained trimmers.

The Coils and I.F.s are supplied complete with a factory blueprint giving circuit and values of various components for building a modern 6-valve All-Wave Radiogram Chassis ... Price **21/-**

We have many other high-grade components suitable for the constructor, such as Ganged Condensers with drive and scale, Ganged Switches, Drilled Metal Chassis, Mains Transformers, High-class Speakers, etc. Send us your requirements enclosing stamped envelope.

ARMSTRONG MANUFACTURING CO.
WALTERS ROAD, HOLLOWAY, LONDON, N.7
Phone: NORTH 3213

NEW RECEIVERS AND AMPLIFIERS

GOOD Selection of New Pre-tax and Reconditioned Receivers and Radiograms.—A.C.S. Radio, 44, Widmore Rd., Bromley. [9623]

£15/10 Only, usual price £22.—Wireless World 2 R.F. Receiver, with push-pull quality amplifier, chassis, 10 valves, including tone control stage, 8 watts triode output; ideal for quality reproduction from radio and gramophone; limited number.—Bakers Selhurst Radio, 75, Sussex Rd., South Croydon. [9519]

RECIEVERS & AMPLIFIERS, SECOND-HAND, ETC. N.C.100X and Speaker, in perfect order; best cash offer secures.—Box 2586, c/o The Wireless World. [9627]

R.M.E.69, L.S.I. Model, 250 mains, excellent condition; £30.—Nelson, Sherwood, Douglas, I.O. Man. [9628]

CATHODE Drive 120 Watt 11 Valve American Amplifier, two modern chassis, complete, as new, £35; V. G. Simplat super recording amplifier, dem. soiled, £30.—A.C.S. Radio, 44, Widmore Rd., Bromley. [9622]

Wanted

W.W. Pre-set Receiver and Amplifier (W.W., Aug. 1939).—3rd Floor, 120, Drury Lane, W.C.2. [9626]

WANTED, "Howard" "430" Receiver; state price and particulars.—Turnbull, 2, Merton Rd., Southsea. [9630]

WANTED, several HRO receivers, in good condition, also Hallicrafters.—Write Box 2578, c/o The Wireless World. [9566]

NEW MAINS EQUIPMENT

VORTEXION Mains Transformers, chokes, etc., are supplied to G.P.O., B.B.C., L.P.T.B.; why not you? Imitated, but unequalled.
VORTEXION, Ltd., 257, The Broadway, Wimbledon, London, S.W.19. Phone: Lib. 2814. [9571]

SHORT-WAVE EQUIPMENT

RADIOMART, largest distributors communication equipment, National distributors.—48, Holloway Head, Birmingham. [9555]

HAMMARLUND Super-Pro. SP110, 15-650, £59; National 81X, A.C./D.C., Ham bands, £21/10; Eddystone Special, 15-87 metres, 3 bands, speaker, £17/10; all as new.—A.C.S. Radio, 44, Widmore Rd., Bromley. [9620]

NEW LOUDSPEAKERS

BAKERS Brand New Surplus Speaker Bargains.
EVERY Music Lover Interested in Realistic Reproduction should write for free descriptive leaflet now.

£5/10; usual price £10.—Brand new permanent magnet infinite baffle speaker, complete with beautifully finished cabinet in polished walnut.

£2/10; usual price £5.—Brand new super magnet model; exceptional bargain; limited number.
SECURE One of These Exceptional Bargains Now.

BAKERS Triple Cone Conversions Will Immensely Improve Reproduction of Your Present Speaker. ("For a few shillings you have converted a speaker scheduled for the scrap heap into one worth pounds.—W. E. Darby, Grad.I.E.E.") Write for details.
BAKERS SELHURST RADIO, 75, Sussex Rd., Sth. Croydon. [9423]

SECOND-HAND LOUDSPEAKERS

HARTLEY-TURNER Speaker and Partridge I.V. 120 Transformer.—Particulars to Hunt, Park Crescent, Torquay. [9638]

CABINETS

A CABINET for Every Radio Purpose.
SURPLUS Cabinets (Undrilled) from Noted Make.

WE Have Hundreds in Stock (no Catalogues); send measurements of chassis, etc., and say what kind of cabinet required; stamp for reply.
INSPECTION Invited.

H.L. SMITH and Co., Ltd., 289, Edgware Rd., W.2. Tel.: Pad. 5891. [9531]

SEVERAL Super Radiogram Cabinets, callers only.—A.C.S. Radio, 44, Widmore Rd., Bromley. [9621]

GRAMOPHONE EQUIPMENT

AMERICAN Capehart Auto-Changer, for 20 mixed records, turning over, as new; £65.—44, Widmore Rd., Bromley. [9617]

Wanted

220V. D.C. Turntable and Reproducer, complete.—Lansley, 32, Manor Rd., Rugby. [9625]

DDOUBLE Turntable Unit Wanted, in portable case; cash.—Langlands, 2, Poultry, Cheapside, E.C.2. [9637]

ACOUSTICAL AMPLIFIERS TRANSFORMERS P.A. EQUIPMENT

NOW OR NEVER!

This seems to be the position with regard to amplifiers and P.A. equipment. A very limited number of our **C25 AMPLIFIERS** are still available for private or commercial use without Government Priority.

If you are considering the purchase of an amplifier in the near future, you will be well advised to get it NOW. The C25 is equally suitable for mobile or stationary use.

30 w. undistorted output—Operates direct from 12 v. car battery or A.C. Mains—Built-in pre-stage amplifier—Automatic matching of any speaker equipment.

Write for full technical specification.

Whatever your P.A. problems, we can help you.

ACOUSTICAL MANUFACTURING CO.

138-140, Wardour St. London W.1
Telephone—GERrard 6265

RELAYS

for A.C. and D.C.

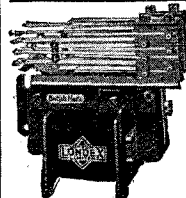

SILENT & RELIABLE
2 VA coil consumption, from 2-600 volts, tested to 2,000 volts. Unmounted and in cast iron casing. Also Time Lag Relays. High Sensitive Relays, complete control plants.

Apply for leaflet SPN/WW

LONDEX LTD.

Electrical Remote Control Engineers and Manufacturers
Anerley Works, 207, Anerley Road, London, S.E.20
Tel.: SYDENHAM 6258/6259.

TRIX SOUND EQUIPMENT

RELIABLE AMPLIFICATION
The TRIX ELECTRICAL COMPANY LTD.
65, Bolsover St., London, W.1. Euston 5471

GALPINS

ELECTRICAL STORES
21 WILLIAM ST., SLOUGH, BUCKS

Phone: SLOUGH 20855

Terms: Cash with Order

ELECTRIC LIGHT CHECK METERS, small, late type, well-known makers, in good condition, electrically guaranteed for 200/250 volts 50 cy. 1 phase A.C. mains. 5 amp. type, 6/-; 10 amp., 7/6; 20 amp., 9/- each. Post 1/- on all types.

D.C. ELECTRIC LIGHT CHECK METERS, 200/250 volts, 5 and 10 amps., 4/6 each, post 1/- (in new condition).

EX R.A.F. SWITCH PANEL, with case (new), fitted 6 small knife switches, leads, cords and cleats, complete in wood case, 2/6 each, post 6d.

VOLTAGE CHANGING TRANSFORMERS (Auto Wound), 100/110 to 200/240 v., or vice versa, fully guaranteed, 1,000 watts, 60/-.

DUG-OUT LAMPS, Ex R.A.F., solid brass construction, glass dome, complete with 12-volt bulb (any bulb can be fitted), wall fitting, 3/- each, post 6d.; Ditto, wing type, as new, 2/6, post 6d.

DUG-OUT LAMPS, Ex R.A.F., porthole type, or can be bracket fitted, glass dome, three colour fitting, white, red or green, solid brass construction, 6in. dia., complete with bulb; any size bulb can be fitted. Price 5/-, post 6d.

EX R.A.F. AUTOMATIC CHARGING CUT OUTS AND VOLTAGE REGULATORS, to suit any dynamo up to 20 volts at 15 amps., fully adjustable, wiring instructions, complete in metal case. Price 3/6, post 9d.

DYNAMOS, all shunt wound and fully guaranteed, 50/75 v.-15 a., 26/10/-, all carriage forward.

110-VOLT D.C. MOTOR, totally enclosed, rated at 8 amps, ball bearing, in new condition, make good slow-speed dynamo, 22/5/-, carriage forward.

GUNMETAL PULLEYS, 7in. diameter, to take 1in. dia. rope, complete with rope guard and hook, 7/6 each, post free.

1/4 H.P. 110 v. D.C. MOTOR, in good working order, 25/-, carriage forward.

FLOODLIGHTS, 12in. dia., multi mirror type with 5in. dia. margin spot centre, any bulb can be fitted, 15/-, carriage paid.

PRESS-BUTTON UNITS, 8-way, 7 x 6 x 1 1/4 ins., fitted capacitors, condensers, etc. Price 5/6, post free.

ROTARY CONVERTER, D.C. to A.C., input 220 volts D.C., output 85 volts 2 kW., 50 cycle, 3 or 1 phase. Price 25, carr. forward.

BELL PUSHES, Ex G.P.O., solid ebonite, two silver contacts, as new, 1/6, post free.

TUNGSTEN CONTACTS, new, one fitted screw and one fitted blade, 1/9 the pair, post free.

HT 8 RECTIFIERS, second-hand, in perfect order, 7/6, post free.

MAINS CHASSIS by famous maker (bomb salvage), complete with mains transformer, tuning coils, condensers, resistances, etc., etc., 4 and 5 v. models (no valves), latest type, not guaranteed to work but offered for value of components only, shortly unobtainable. Price 25/-, post free.

UNIVERSAL CHASSIS (no transformer). Other particulars as above. Price 20/-, post free.

SALVAGE CHASSIS, all damaged, offered for value of components, guaranteed value. Price 7/6 or 12/6 each, post free.

ASSORTED WIRE END AND TUBULAR CONDENSERS, all good, 2/6 per doz., post free.

WARD

WE MANUFACTURE:

ROTARY CONVERTERS
 DC/AC for operating P.A. amplifiers, Radio Receivers, etc.

DC/DC ROTARY TRANSFORMERS, SMALL ALTERNATORS, SMALL DC MOTORS, H.T. GENERATORS, MAINS TRANSFORMERS up to 10 k.v.a. **PETROL ELECTRIC** generator sets up to 50 k.v.a.

BATTERY CHARGERS for private and industrial use

We can also handle general small engineering work.

Full details of any of the above upon request

CHAS. F. WARD

Note new address owing to enemy action, Office and Works:—

37, White Post Lane, Hackney Wick, E.9

Tel.: Amherst 1393.

VALVES

Wanted

WANTED.—Ostar-Ganz valves, NG100 rectifiers and G.5 frequency-changers in working order, 200-250 volt, 7-pin bases; state price.—Lindsay, 47, Queen's Rd., Bradford, Yorks. [9616]

TEST EQUIPMENT

MULTIMETER Kits (Less Meter), close-tolerance shunts and resistances, instrument switches, etc. We supply designs all types test apparatus to clients' requirements.—MacLachlan and Co., Strathyre. [9639]

Wanted

W.W. Test Oscillator, or components for same.—10, Strawberry Terrace, Garforth, Leeds. [9635]

WANTED.—oscillator oscillograph universal avometer.—Lawson, 137, Wellington St., Kettering. [9646]

DYNAMOS, MOTORS, ETC.

ROTARY Converter, 220 D.C. to 230 A.C., 100 watts.—Box 2587, c/o *The Wireless World*. [9643]

ALL Types of Rotary Converters, electric motors, battery chargers, petrol-electric generator sets, etc., in stock, new and second-hand.

WARD, 46, Farringdon St., London, E.C.4. Tel.: Holborn 9703. [0518]

MORSE EQUIPMENT

FULL Range of Transmitting Keys, practice sets and equipment for Morse training.—Webb's Radio, 14, Soho St., London, W.1. Phone: Gerrard 2089. [9553]

BUSINESSES FOR SALE OR WANTED

"THE Wireless and Electrical Trader" is an essential part of the equipment of every Wireless Trader, its pages reflect the very latest turn of trade events, and it is read by all the leading dealers and manufacturers, for particulars of businesses offered or wanted. By subscription, to the trade only, 17/6 per annum, post free.—Send your trade card for specimen copy to Dorset House, Stamford St., London, S.E.1. [0614]

REPAIRS AND SERVICE

L.T.P. Repair All Mains Transformers and Chokes. Prompt delivery.

LONDON TRANSFORMER PRODUCTS, Ltd., Willesden, N.W.10. Wil. 6486 (3 lines). [9552]

EPOCH, genuine replacement diaphragms, all models. —"R.E.C.S.", Crown St., Reading. Phone: 2796. [9631]

MAINS and Output Transformers, chokes, etc., rewound.—Davies, 30, Morley Ave., Manchester, 14. [9645]

MAINS Transformer Service, repairs, rewinds, or construction to specification of any type, competitive prices and prompt service.—Sturdy Electric Co., Dipton, Newcastle-on-Tyne. [0516]

"SERVICE with a Smile"—Repairers of all types of British and American receivers; coil rewinds; American valves, spares, line cords.—F.R.I., Ltd., 22, Howland St., W.1. Museum 5675. [8934]

METROPOLITAN RADIO SERVICE Co. Guarantee Repairs to American and British Receivers. Linecord resistances, condensers, and volume controls. Trade supplied.—1,021, Finchley Rd., N.W.11. Spe. 3000. [9641]

NEW COMPONENTS

U.H.F. Trimmers, air-dielectric, steatite, 4-40 mmf., 3/-; Driver transformers, 4/9; quantity other new components.—MacLachlan and Co., Strathyre. [9640]

AERIAL Equipment.—Insulators, Short-wave five ring quartz 3in. long, non-hygroscopic, 3/6 a dozen. Small porcelain shell, 1/- per dozen. 12in. stand-off, 4/6 per dozen. Aerial wire, 7/22 copper, 2/6 per 100ft. coil. All carriage paid. Cash with order or c.o.d.—P. and F., 49, John Bright St., Birmingham, 5. [9661]

COMPONENTS, SECOND-HAND, SURPLUS, ETC.

SOUTHERN RADIO'S Wireless Bargains.

ALL Goods Previously Advertised Still Available.

SOUTHERN RADIO, 46, Lisle St., London, W.C. Gerrard 6653. [9238]

G. A. RYALL, Arnehurst, Marsh Lane, Taplow, Bucks.—Goods advertised April issue still available, except Amplifiers, Speakers and Transformers. [9644]

FORMO Ceramic Ribbed 2in. x 1 1/4in. Coilformers, 3/6 per doz., 30/- gross; Formo Ceramic bases for above, 2 1/2in. x 1 1/2in. x 1 1/4in., 5-hole, without fittings, per doz. 1/9, 15/- gross.—A.C.S. Radio, 44, Widmore Rd., Bromley. [9618]

A MATEUR'S Clearance.—Meters, pickup, Tungsar battery charger, headphones, components, typewriter. Send stamp for list.—Cawley, Sunningdale Drive, Chapel St. Leonards, Skegness. [9636]

HAYNES R2 Tuner, Telefunken pickup, Garrard motor 201A, Goodman speaker HF, PM, in cabinet, RK speaker, all as new; offers.—Proprietor, Jolly Gardener, Maidens Green, Bracknell, Berks. [9634]

R·S Sound Equipment

is designed for 'Active Service' in the Field, Factory and Public Building.

We say 'Active Service' in the sense that it will stand up to really hard work over long periods and will do its job well and thoroughly.

Whether your interest in purchasing Sound Equipment is private, industrial or associated with the present National Emergency, you will find an investigation of the R.S. Amplifiers range, well placed and well repaid.

The items listed below are representative of our apparatus and full details will be sent on request. Let us know your special needs and we'll be happy to co-operate.

AMPLIFIERS

"M.M. Twin."—Double speaker equipment giving 12 watts output. Five valves, AC/DC 190-260 volts. Complete with "mike," stand and cables.

"Universal Fifteen."—15 watts output. Two speakers. AC/DC 190-260 volts. High and Low impedance input. Complete with "mike," stand and cables.

"Porta Thirty."—30 watts output. Two speakers (this equipment can accommodate up to fifteen speakers!). AC 200-250 volts. Complete with "mike," C.P. stand and cables. The acme of perfection in portable amplification.

CHASSIS

Five types of chassis are available: 50 watt, 30 watt, 15 watt, 12 watt and a 12-watt Battery Unit.

Crystal Microphones and Stands. Speaker Units (Exponential Horns), 11 watts and 13 watts capacity.

R·S Amplifiers

LIMITED

THREE & FOUR HIGHFIELD ROAD SHEPPERTON - MIDDLESEX

Phone: Walton-on-Thames 1019

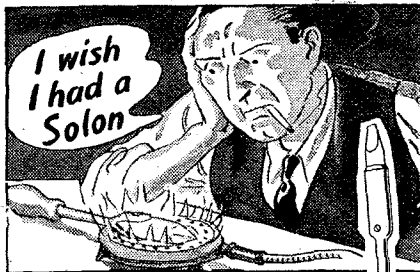

The SOLON saves time & trouble

No waiting for re-heating with the Solon! Once hot (and that takes only 4 minutes) it stays hot! 15 hours continuous soldering uses only 1 unit. That's why Solon Electric Soldering is better, neater, stronger, and far easier. Get a Solon and do the job properly!

Made for the following standard voltages:—200/220, 230/250.



Handyman model supplied complete with Resin-Cored Solder, Flex and Lamp Adaptor **9/4**
Solon Resin-Cored Solder **6P.** per reel.

W. T. HENLEY'S TELEGRAPH WORKS CO. LTD.
(Dept. 22/E), Engineering Sales Dept., Milton Court, Westcott, Dorking, Surrey.



FOR THE RADIO SERVICE MAN, DEALER AND OWNER

The man who enrolls for an I. C. S. Radio Course learns radio thoroughly, completely, practically. When he earns his diploma, he will **KNOW** radio. We are not content merely to teach the principles of radio, we want to show our students how to apply that training in practical, every-day, radio service work. We train them to be successful!

INTERNATIONAL CORRESPONDENCE SCHOOLS

Dept. 38, International Buildings, Kingsway, London, W.C.2.
Please explain fully about your instruction in the subject marked X.
Complete Radio Engineering
Radio Service Engineers
Elementary Radio **Television**
If you wish to pass a Radio examination, indicate it below.
Inst. of Wireless Technology
P.M.G. Certificate for Wireless Operators
Provisional Certificate in Radio Telephony and Telegraphy for Aircraft
City and Guilds Telecommunications

Name..... Age.....
Address.....
(Use penny stamp on unsealed envelope)

RADIO CLEARANCE, Ltd.

- LOW-LOSS Ceramic Valve Holders, Lissen Hi-Q,** baseboard and chassis, 7-pin; 1/- each.
- PUSH-PULL Switches, Lissen 2-point, 4d. each;** Yaxley type switches, 6-bank, 3/- each; Yaxley type switches, 9-bank, 3/6 each.
- MIDGET Speakers, Goodmans energised, 600 ohms** field, including transformer, new, boxed; 10/6 each.
- STRAIGHT Line 3 Wave-band Dials; 1/11 each.**
- MAINS Transformers, 300-0-300v. 100 m.a., 5v. 2** amps, 6.3 5 amps, drop-through chassis type; 12/6 each.
- MAINS Transformers, Wearite 100w. auto trans-** formers, 100-110v. 200-250v., reversible; 14/11 each.
- MAINS Transformers, 250-0-250v. 80 m.a., 4v. 1** amp., 4v. 4 amp., 200-250 mains, new, boxed; 12/6 each.
- CHASSIS Mounting Valveholders, English Clix type,** 4-5-7-pin; 3d. each.
- CENTRALAB Volume Controls, midget type, 2,000,** 5,000, 25,000, 50,000, 100,000 ohms, less switch, 2/9 each; 1,000, 25,000, with switch, 3/6 each.
- DROPPING Resistances, for all purposes, total** resistance 535 ohms 5 taps in steps of 50 ohms, standard for Pye, Lissen, EverReady, etc.; 3/6 each.
- 10 FT. Coils Connecting Wire, 4d. each, glazed,** red or white.
- BRAIDED Screened Cable, single and twin; 9d. per** yard.
- PUSH-ON Pilot Lamp Holders; 3d. each.**
- PLESSEY Single Gang 0.0005 Variable Condensers,** 1/11 each; 2-gang 0.0005 variable condensers, with Vernier control, 1/11 each.
- SOLID Dielectric Condensers, by well-known maker,** 0.0005 tuning and 0.0001 reaction differential; 6d. each.
- MAINS Energised Speakers, by well-known makers:** 6,000, 2,000, 3,000, 2,500, 1,500 and 1,000 ohms; 12/6 each, complete with transformer.
- PHILIPS All-wave Chassis, battery, A.C. and univer-** sal, from 15/- each.
- MAINS Transformers, 350-0-350v. 4v. 5 amps., 500-** 0-500 4v. 1 amp., 6.3v. 4v. 2 amp., 12/6 each; 10-way push button switches; 1/3 each.
- B.I. Wire-end Bias Electrolytics, 50 mfd. 12-volt;** 1/6 each.
- TUBULARS Wire-end Non-inductive Paper Con-** denser, all sizes up to 0.01, 5d. each; 0.1, 7d. each.
- T.C.C. 2 mfd. Electrolytic Condensers, 200v. wkg.;** 1/3 each.
- CONDENSERS, 0.0005 Triple; 1/9 each.**
- T.C.C. 1 mfd. Paper Condenser, 350v. working; 1/-** each.
- DOUBLE Fuse Holders, complete with two 1-amp** fuses; 1/6 each.
- R.I. Parafed L.F. Transformers; 2/- each.**
- GOOD Assortment of Mains and Filament Trans-** formers, L.F. chokes and Alum chassis, etc.
- ALL Orders Must Include Sufficient Postage to** cover; please write your name and address in block letters; we cannot undertake to answer enquiries unless postage is included (2½d.); hours of business, 9-4.30; Saturday, 9-1 p.m.
- RADIO CLEARANCE, Ltd., 95, High Holborn** London, W.C.1.
- TELEPHONE: Holborn 4631.** [9642]
- COULPHONE RADIO, New Longton, Preston.—** Tungsram and American Valves. Latest type P.M. speakers with transformer 8in. Goodmans, 18/6. 10in. Rola, 22/6. Electrolytics, 500v. 8 mfd., 2/9; 8+8 mfd. (4 leads), 4/9; 16+8 mfd., 6/3. 50 mfd. 50v., 2/9. Pick-ups with volume control, 17/6. Erie and Dubilier 1 watt resistors, 6/6 doz. Volume Controls, with switch, 4/3. Tubulars, valve holders, etc. S.A.E. new list. [9624]

Wanted

WE Buy New or Used Radios, amplifiers, meters, converters, radio and electrical accessories, etc.—Phone: Ger. 4447. [9603]

TECHNICAL TRAINING

GREAT Possibilities Exist for Technically Qualified Engineers, key men in wartime and afterwards. Through the home-study courses of The T.I.G.B. take a recognised engineering qualification such as A.M.I.Mech.E., A.M.I.E.E., A.M.I.R.E., A.F.R.Ae.S., A.M.I.Chem.E., C. and G., etc., in which examinations the T.I.G.B. students have gained 25 FIRST PLACES and Hundreds of Passes. Write to-day for "The Engineer's Guide to Success"—Free—containing the world's widest choice of engineering courses covering all branches, including Aeronautical, Mechanical, Electrical, Wireless, Chemical, etc..

THE TECHNOLOGICAL INSTITUTE OF GREAT BRITAIN, 82, Temple Bar, House, London, E.C.4. [9335]

TUITION

RADIO Trainings—P.M.G. exams. and I.E.E. Diploma, prospectus free.—Technical College, Hull. [0611]

L.R.S. TAX-FREE OFFERS!

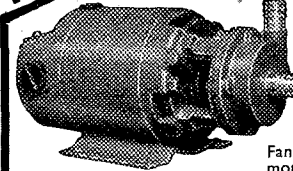

'Stuart' Centrifugal Electric SHELTER PUMP

Quickly clears water from shelters. Ideal for many other A.R.P. uses. A sound job built for continuous running. Prompt Delivery.

Fan-cooled ball bearing motor, A.C. or D.C., any voltage. Low current consumption. Connections for rubber hose. All parts non-rusting. Please state exact mains voltage required.

These pumps (as used on the "Queen Mary.") may also be used for garden fountains.

Fountain Jets 4/- extra.

No. 10.	100 gals. per hour	£5 2 6
No. 11.	280 gals. per hour	£6 6 0
No. 12.	560 gals. per hour	£7 14 0

Prices include foot valve and strainer, and pump is ready for immediate use.

Carriage and packing 2/- extra.

AVOMINOR D.C. TEST METERS

We can supply a limited number of these well-known Meters from stock, Tax Free. Order now. Price £2 17 6. Postage 6d.

MORPHY-RICHARDS ELECTRIC FIRES

We still have a few Tax Free Models available. Also M.R. Electric Irons. Details on Request.

LONDON RADIO SUPPLY CO.

Established 1925
All communications to evacuation address—
"WINDEN," ARDINGLY RD., BALCOMBE, SUSSEX

METAL CASES

FOR RADIO & RADIO INSTRUMENTS
also
CASES & BOXES IN WOOD & REXINE
MANUFACTURERS
of
FABRICATED PARTS IN WOOD
AND METAL TO THE RADIO
AND AIRCRAFT INDUSTRY

Send 2½d. in stamps for details of RADIO CABINETS FOR THE HOME.

LOCKWOOD & CO., Lowlands Road, Harrow, Middlesex. Phone: BYRON 1818.

THE POLYTECHNIC, 309, REGENT STREET, W.1
SCHOOL OF ENGINEERING

Head of School:
PHILIP KEMP, M.Sc.Tech., M.I.E.E., A.I.Meech.E.

RADIO ENGINEERING: A full-time day course in tele-communications, extending over a period of three years, preparing for all recognised examinations and for the radio and telephone industries.

School re-opens 9th September.
Prospectus on application to Director of Education.

"THE ALL METAL WAY"
costs 3d. and will show you how to save £. s. d. in rectifier renewals.

Dept. W.W.
Westinghouse Brake & Signal Co. Ltd.
Pew Hill House, Chippenham, Wilts.

RADIO RECEIVER SERVICING AND MAINTENANCE by E. J. C. Lewis
Everything connected with radio servicing, maintenance and repair is exhaustively dealt with and clearly described. Every point carefully set out for immediate reference. "The book is so practical, so replete in facts, and so well arranged that the reader will quickly gain the necessary knowledge to work in a logical way."—*Wireless World*. 8/6 net (by post 9/-). Pitman's, Parker Street, W.C.2.

RADIOLOCATION!

Are you going to help?

R.A.F. Radio Mechanics and everybody who knows about radio will tell you that these books are the best books to give you up-to-date radio knowledge. Thousands of men are studying them to-day and equipping themselves for useful radio work immediately.

First Course in Wireless (Gives the beginner a good groundwork) 5/- net.

Wireless Terms Explained (Everybody's book explaining radio jargon) 2/6 net.

Introducing Radio Receiver Servicing (No frills; good sound book about first principles and practice) 6/- net.

Superheterodyne Receiver (R.A.F. men must know about superhets) 4/6 net.

Radio Tunes and Repairs for Amateurs (New revised edition of this most popular book ready shortly) about 6/- net.

Definitions and Formulae—Radio (Speaks for itself. Slips into the pocket) 6d.

Radio Books List (30 books) FREE.

RADIO BOOKS YOU'LL NEED

From booksellers or Pitman's, Parker St., W.C.2

SHORT WAVE RADIO by J. H. Reyner
A comprehensive, practical survey of modern developments in the use of short, ultra short and micro-waves by a foremost expert. It provides a great deal of valuable data concerning the practical methods of their use in radio transmission. Extremely important to-day! "One of the finest treatises available."—*Journal of the Institution of Electrical Engineers*. 10/6 net (by post 11/-). Pitman's, Parker Street, W.C.2.

V

stands for
VICTORY

YOU can achieve speedy success in mastering the
MORSE CODE

Candler Code Courses will start you on the right road to securing a thorough training, or help you to increase your present speeds so that your services will be valuable to the Army, Navy, Air Force, merchant marine, or to commercial companies.

A Candler trained operator now serving in the R.A.F. says:—

"... I should like to thank both yourself and the company for the great start which I obtained through taking your Junior Code Course. The experience which I gained from that, has kept me 'miles in front' of others who relied on obsolete means of learning code."

Post the Coupon below for full details of Candler Code Courses.

JUNIOR Scientific Code Course for beginners. Teaches all the necessary code fundamentals scientifically.

ADVANCED High-speed Telegraphing for operators who want to increase their w.p.m. speed and improve their technique.

Either Course is supplied for Cash or on Monthly Payment terms.

COUPON

Please send me Free and without obligation a copy of the Candler "Book of Facts."

NAME.....

ADDRESS.....

Post coupon in *id. unsealed envelope to London Manager*
(Room 55W) 121, KINGSWAY, LONDON, W.C.2

CANDLER SYSTEM CO.

Candler System Co., Asheville, North Carolina, U.S.A.

PRACTICAL Radio Postal Courses, coaching for I.P.R.E., R.A.F., A.I.D. exams; booklet free.—Secretary, I.P.R.E., Bush House, Walton Avenue, Henley-on-Thames. [9547]

RADIO Engineering, Television and Wireless Telegraphy; comprehensive postal courses of instruction.—Apply British School of Telegraphy, Ltd., 179, Clapham Rd., London, S.W.9 (Estd. 1906). Also instruction at school in wireless for H.M. Merchant Navy and R.A.F. [9249]

SITUATIONS VACANT

AIR MINISTRY.
CIVILIAN W/T Operators Required, age 28 to 45, preferably with 1st Class P.M.G. or Air Operator's Certificate in Wireless Telegraphy, and experience in Radiotelephony, Direction Finding and Wireless Maintenance work.

SALARY 75/- a Week, rising to 125/- a week, plus temporary war bonus.

APPLY by Postcard for Application Form and Full Particulars to the Under-Secretary of State, Air Ministry, (S.I.(e)), Julian Road, Bristol, 9. Third class fares will be refunded to candidates required to attend for interview. [9586]

WIRELESS Technical Instructors Required in Army Units.

EMOLUMENTS.—Pay 8/9 per day (7 days a week); clothing, rations and accommodation, or if this cannot be provided allowances at authorised rates; if married and otherwise eligible, family allowance payable in respect of wife and children, subject to allotment from pay.

CANDIDATES Should Preferably be under 35 and over 24, and

(A) Hold one of the following qualifications:—

Graduateship of the Institution of Electrical Engineers.

Final (Grade III) Certificate of City and Guilds of London Institute Examination in Radio Communication.

Higher National Certificate in Electrical Engineering.

Certificate of City and Guilds of London Institute in Radio service work.

Or

(B) Be able to pass an examination on the following syllabus:—

Simple algebra, including quadratic equations; simple trigonometrical ratios and identities; vectors.

Properties of electrical currents; heating of conductors; magnetic fields; unit of current; Ohm's Law; resistance in series and parallel; potentiometers.

Magnetic effect of current fields due to parallel wires; field due to a solenoid; electro-magnets. Meters.

Induction; effect of rotating a coil in a magnetic field.

Mutual and self induction and inductance; effect of inductance on growth and delay of current.

Capacity; charging storage and discharge of condensers; through resistance and inductance.

Alternating currents; vector diagrams; effect of resistance variation; effects of L and C in A.C. circuit; phase difference of currents; resonance in a series circuit; parallel circuit of L and C; Q factor.

Elementary knowledge of valves; simple theory of amplifiers, oscillators and detectors; general principles of radio practice.

SUITABLE Candidates will be Interviewed at Local Centres, and, if successful, will be enlisted and appointed Acting Sergeant Tradesman. For those who are on the Schedule of Reserved Occupations, special arrangements will be made to enable them to be enlisted. In the event of any applicant found to be reserved under Schedule of Reserved Occupations special application will be made for relaxation of the Schedule. No guarantee can be given that this application will be successful.

APPLICATION Forms may be Obtained by Postcard from the Under-Secretary of State, The War Office (A.G.6c), Whitehall, S.W.1. [9520]

MISCELLANEOUS

FLUORESCENT Powders for Disposal, various colours, good quality, particulars.—Shannon, 21, Quadrant Close, Hendon, N.W.4. [9614]

LESLIE DIXON and Co., would appreciate any electrical and radio catalogues to replace those lost by enemy action.—These should be sent to our new office at 19, Broughton St., Battersea, S.W.8. [9615]

REORDER, portable, American Presto Jr., with 6 discs, as new, £50; Permarec electric baking oven, 30/-.—A.C.S. Radio, 44, Wandmore Rd., Bromley. [9619]

Wanted

HOOVERS, floor polishers, etc., in any condition. "R.E.C.S.," Crown St., Reading. Phone: 2796 [9632]

VACUUM CLEANERS

ELECTROLUX, £7/7; brand new Protos, £6/19/6 (no tax); Hoover, £10/10; Stewart, 50/-; BTH Newmode, £9/9. We buy Hoovers, floor polishers, motors, etc.—"R.E.C.S.," Crown St., Reading. Phone: 2796. [9633]

PRINTING

CARDS, memos, tags, b'heads, 1,000, 7/6. Rubber stamps, samples.—Tice's, 11, Oaklands Grove, W.12. [9629]

ELECTRADIX

Signal Gear

MORSE KEYS. Type B.1, a strong key, 5/-, Bakelite base type M, 6/6. A first-class key, type P.F., plated fittings, well balanced, 9/6. The best key available is type IV, 12/6. Special Government extending folding Fuller Service Key, few only, 17/6.

BUZZERS. Bakelite cased practice Buzzers, 3/6. Neat brass cased Buzzer, 4/6. Heavy type, Bakelite cased, 5/6. D.3 Buzzers, multiple windings, no contacts, 5/-.

Cambridge - Townsend. High Note model, "T" diaphragm blade, platinum contacts, smallest Buzzer made, 10/-.

Receivers for Signals, powerful L.R. metal-clad receiver, fitted no-flare horn, Dictograph make, amplifies buzzer signals, 7/6.

TELEPHONES. We are often asked for the modern bakelite handcoms and can now offer a few of the G.P.O. type in brown at 27/6, and resting cradle stand 3/6.

Midget L.R. Impedances, iron cored, 2-coil phone type, 2/3.

MIKES. Metal-clad Mikes, can be used as they are, or in any case, 5/-.

G.P.O. Mike Buttons, specially selected, 2/6.

RELAYS. Single Pole No. 4A on-off, 2 volts, phone type, 5/-.

No. 6 Relay, twin bobbin, 6 volts 25 m.a., S.P.C.O., 8/6.

Relay Movements, less contact blade, new, 2/6.

Pocket Thermometers in metal case, useful in the Service, 2/6.

Field Telephone Cable. A few miles left, single or twin. Ceiling Roses, porcelain, with 2 Screw couplers, make good connect boxes, 6/6 doz. Edison Steel Cells A.8 in stock.

Morse Inker Tape Recorders for sigs. on paper tape. Have some new captured contraband, latest Continental high-speed model, bargain at 27/10/-.

Mains Magnets, disc type, 2 poles wound, laminated 110 volts or 220 volts, lifts 7 lbs., 4/6.

Hand-drive alternator or magneto bell ringer P.M. Magnets, geared, gives 80 volts 25 m.a., useful where no A.C. available, 10/6.

Condensers. Fixed S.P.O. 2 M.F. smoothing, 2/-.

Variable air solo Formo Condenser, .0005 mf., boxed in original carton, 2/6.

Dynamo Bargains

110 volts, 8 to 1 amp. D.C. ball-bearing semi-enclosed, 1,850 revs., 15 lb., 6in. x 5in., cheap, carriage paid, 15/6.

200 volts 1 amp., 21/-; 200 volts 1 1/2 amp., 36/-.

Double Current Government, cost £15. Two commutators D.C., 6/8 volts 3/5 amps and H.T. 400/600 volts 100 mm., 5 1/2 in. dia., 12in. long, 17 lbs., 4,000 revs., ball bearings, 25/-.

Large size, 500 watts, 18 volts, 20 amps. and 400 volts 200 m.a., 25.

VALVES. "WECO" Peanuts midget, 4 pin. 1 volt triodes, new, 3/6. Cossor A.T.40 6-volt power valves, 4/6.

Neon lamps with letter cathodes, 230 volts, 2/6.

Motors

MICRO MOTORS. A.C. split phase synchronous motors, squirrel cage rotor, 1/2 in. dia. Dog clutch drive to reduction gear from 2,000 revs. to 58 r.p.m. Voltage 15 to 20 volts, 50 cycles, reversible, double shaft, enclosed, laminated, new. Suit model drive. Remote control switching, tuning drive, etc., 8/-, post free.

Small A.C. MAINS MOTORS. Enclosed, self-start on load, 230 volts, 1/30 h.p., Type 40, 1,500 revs., 18/6.

Split phase, 1/10 h.p., 2,500 revs., 45/-.

Small D.C. MAINS MOTORS. 1/40 h.p., Type 60, 220 volts, K.B. series, 1,750 revs., 15/-.

Ditto, 1/12 h.p. Croydon 110 and 230 v. shunt, 1,700 revs., 30/-.

M.G. for A.C., 220 volts to 100 volts 1 amp. D.C., 77/6.

100 volts, 15/-.

Engine Sets

500 watt single cylinder 2-stroke, water-cooled self-oiling Pelapone engine, mag. ign., coupled to 50/70 volts, 10 amps, shunt dynamo, 1,000 r.p.m., £17/10/-.

Horizontal Twin Petrol A.B.C. Engine, fan-cooled, coupled 1 1/2 kW, D.C., dynamo 50/70 volts 25 amps, mag. ignition. Cost £190. Sale, £25. 2 1/2 kW.

Austin 4-cyl. water-cooled Engine, mag. ignition and 110 volt dynamo, 3 1/2 kW., £48. Send stamp for details.

Please add postage for all mail orders and send stamped envelope for replies to enquiries.

We have left Upper Thames Street, and our new offices adjoin our Works at Battersea, No. 137 bus route. 2796 fare from Sloane Square.

PLEASE NOTE NEW ADDRESS

ELECTRADIX RADIOS
19, BROUGHTON STREET
Queenstown Rd., London, S.W.8
(Telephone available shortly.)

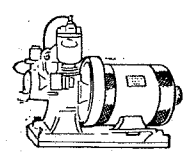
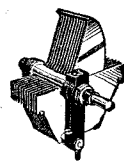
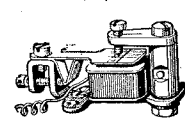



ENGINEERING OPPORTUNITIES

This unique Handbook shows the easy way to secure A. M. I. C. E., A. M. I. Mech. E., A.M.I.E.E., A.M.I.A.E., A. M. I. W. T., A.M.I.E.E., and similar qualifications. **WE GUARANTEE—“NO PASS—NO FEE.”** Details are given of over 150 Diploma Courses in: all branches of Civil, Mech., Elec., Motor, Aero Radio and Production Engineering, Draughtsmanship, Training, Inspection, Government Employment, BUILDING (the great after-war career), R.A.F. MATES, etc. Write for this enlightening Handbook to-day, **FREE** and post free. Men with Radio knowledge can obtain attractive posts in the Services.

BRITISH INSTITUTE OF ENGINEERING TECHNOLOGY, 387 Shakespeare House, 17, 18, 19 Stratford Place, London, W.1

THE BEST WAY to LEARN MORSE

“MASTERS” INSTRUCTIONAL RECORDS

Prepared by an ex-Royal Corps of Signals Instructor, these records contain messages at a speed up to 20 words per minute. Private Tuition given. Details on request.

Price 4/- each or Complete Set of Three 10/-

C. E. MASTERS,
43, GROVE PARK ROAD, CHISWICK, W.4

WIRELESS DIRECTION FINDING *Third Edition*

800 pages
550 illustrations

By R. KEEN, B.Eng.

Price 25/- net. By post 25/9

From leading Booksellers or direct from the Publishers

ILIFFE & SONS LTD.,
Dorset House, Stamford St., London, S.E.1

BOOKS, INSTRUCTIONS, ETC.

WEBB'S Radio Map of the World Locates Any Station Heard. Size 40x30in. 4/6, post 6d. On linen, 10/6, post 6d. Webb's Radio Globe, 12in. model. Radio prefixes, zones, etc. 27/6.—Webb's Radio, 14, Soho St., London, W.1. Phone: Gerrard 2089. [9554]

EVERY Radio Dealer Who is Not a Regular Reader of "The Wireless and Electrical Trader" should send his trade card at once for a specimen copy and full details of the "Trader" Services. "The Wireless and Electrical Trader" has the widest influence, and is read by all the leading manufacturers and traders. Trade only, 17/6 per annum, post free. Published at Dorset House, Stamford St., London, S.E.1. [0615]

WALSALL EDUCATION COMMITTEE

The Walsall Technical College is prepared to receive applications from suitable qualified persons able to act as temporary full-time instructors in Army courses demanding knowledge of Radio Engineering and radio service work.

Applications to be made to the Principal, Technical College, Bradford Place, Walsall.

Education Offices, Darwall Street, WALSALL

V. J. Moore, Director of Education.

This space reserved for



W. BRYAN SAVAGE LTD.

LEARNING MORSE

Eighth Edition

AN EASY METHOD OF MASTERING THE INTERNATIONAL SIGNAL CODE

Price 6d. NET. By post 7d.

Published from the Offices of **THE WIRELESS WORLD**

Iliffe & Sons Ltd., Dorset House, Stamford St., London, S.E.1.

SECOND EDITION—NOW ON SALE

RADIO LABORATORY HANDBOOK

By **M. G. SCROGGIE, B.Sc., A.M.I.E.E.**

Issued in conjunction with "The Wireless World"

This practical and reliable handbook, the only one of its kind, gives complete information about laboratory equipment, and the correct methods of working.

The new edition has been extensively revised, and many important additions have been made. Q-meters, crystal-controlled frequency calibrators, and double-beam cathode ray tubes have been included.

There is also a collection of the most useful formulae, symbols and abbreviations, with tabular and other data.

401 pp. 219 illustrations and diagrams

Price 10/6 net. By post 11/1

ILIFFE & SONS LTD., Dorset House, Stamford Street, London, S.E.1

Sixth Edition—Revised and Enlarged

WIRELESS SERVICING MANUAL

By **W. T. COCKING, A.M.I.E.E.**
(of "The Wireless World")

A complete book of reference. The most reliable practical guide for amateur and professional.

6/- net By post 6/6

Issued in conjunction with "THE WIRELESS WORLD" and Published by the Proprietors:—

ILIFFE & SONS LTD., DORSET HOUSE, STAMFORD STREET, LONDON, S.E.1

FOR THAT INDOOR P.A. JOB (and especially for speech)

Use your **VOIGT loudspeaker unit** with one of our 2 ft. mouth horns. It dismantles easily for transport and storage.

Price - £4 - 16 - 3 (ex works)

UNIT WITH TWIN DIAPHRAGM
£15 - 15 - 0 (about 40 watts required for full excitation)

VOIGT PATENTS LIMITED
THE COURTS, SILVERDALE, SYDENHAM, S.E.26
Telephone: SY Denham 6066.

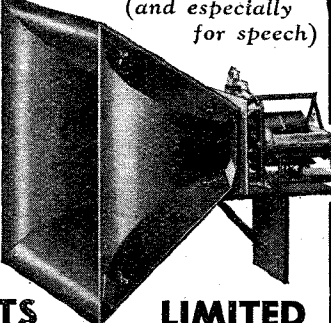

RADIO DESIGNER'S HANDBOOK

A Comprehensive Manual for Radio Engineers and Experimenters

Edited by **F. Langford Smith, B.Sc., A.M.I.E.E.**

This handbook is a complete collection of all the principal formulae involved in the design of receivers and components. The eight sections of the book deal with Audio Frequencies; Radio Frequencies; Rectification; Filtering and Hum; Receiver Components; Tests and Measurements; Valve Characteristics; General Theory; Sundry Data.

Full explanations are given of the way the principles are applied and each chapter gives a list of works dealing with the particular subject.

Size 8 1/2 x 5 1/2 inches, 352 pages with numerous diagrams and charts. Cloth boards

Price 8/6 net. By Post 9/1

ILIFFE & SONS LTD., Dorset House, Stamford Street, London, S.E.1

THE SIMMONDS GROUP

INVENTORS

We continually seek new inventions and products in all branches of industry for development and production by the manufacturing Companies of the Simmonds Group throughout the world.

SIMMONDS DEVELOPMENT CORPORATION LTD.
BUSH HOUSE, W.G.2.



Printed in England for the Publishers, ILIFFE AND SONS LTD., Dorset House, Stamford Street, London, S.E.1, by THE CORNWALL PRESS LTD., Paris Garden, Stamford Street, London, S.E.1. "The Wireless World" can be obtained abroad from the following: AUSTRALIA and NEW ZEALAND: Gordon & Gotch, Ltd., INDIA: A. H. Wheeler & Co. CANADA: Imperial News Co.; Gordon & Gotch, Ltd. SOUTH AFRICA: Central News Agency, Ltd.; Wm. Dawson & Sons (S.A.), Ltd. UNITED STATES: The International News Co.

LEARN ABOUT THE MODERN SPEEDY WAY OF SOLDERING



THE TWO MOST INFORMATIVE PUBLICATIONS ON SOLDERING

Two publications have been issued by Multicore Solders Ltd., which give much useful information about soldering in general, in addition to facts about the advantages of Ersin Multicore Solder, with its three cores of non-corrosive ErsinFlux. Executives are invited to send for copies of these publications and a free sample of this A.I.D. and G.P.O. approved solder.

MULTICORE SOLDERS LTD.
BUSH HOUSE, LONDON, W.C.2

Tel: TEMple Bar 5583/4

B.I. RADIO MATERIALS

We have had a long experience in the manufacture of all kinds of Cables and Wires, Aluminium Sheets and Strips, Static Condensers, Insulators and Iron Work, Telephone Cords and Copper Earthing Rods, for Radio use.



U.K. Regd. Trade Mark.

BRITISH INSULATED CABLES LTD.

CABLE MAKERS AND ELECTRICAL ENGINEERS
Head Office :

PRESCOT, LANCs. Tel. No. PRESCOT 6571

WHARFEDALE GOLDEN CHASSIS



As supplied to the
B.B.C.

Supplies of this first-class Loud Speaker are still available.

Delivery 2/3 weeks.

PRICES :

	Less Trans.	With Trans.
Chassis only - - -	60/-	75 -
Cabinet Model - - -	97/6	112/6

RESPONSE CURVE

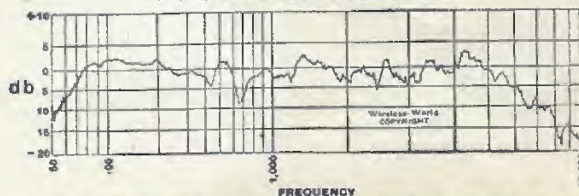

WHARFEDALE WIRELESS WORKS

SOLE PROPRIETOR : D. E. BRIGGS,

HUTCHINSON LANE, BRIGHOUSE, YORKS.

'PHONE : BRIGHOUSE 50.

'GRAMS : " WHARFDEL."

ROLA

LOUD SPEAKERS

THE WORLD'S FINEST REPRODUCERS

TRANSFORMER LAMINATIONS

Core Width $\frac{3}{8}$ " to $1\frac{1}{2}$ " (E's & I's)

EIGHT STOCK SIZES

A Comprehensive Bulletin together with details of Associated Covers and Clamps with design data will be sent to manufacturers on request.

BRITISH ROLA LIMITED

MINERVA RD., PARK ROYAL, N.W.10. WILloden 4322

marconi's make it.

★ *If it is a matter of wireless apparatus for broadcasting or television; for naval or military purposes; for marine or air communications; for mobile or fixed aids to navigation; for any application whatever to practical requirements . . . ask Marconi's.*

Because now, as in the earliest days of wireless experiment, Marconi's are pioneers in design and leaders in technical efficiency.

For full particulars of all types of wireless apparatus, apply to Marconi's Wireless Telegraph Co., Ltd., Electra House, Temple Place, London, W.C.2.